

FURNITURE PROFILES **CATALOGUE**



 **Thermoplast**[®]

www.thermoplast.eu



Thermoplast was established in Poland in 1989 as a Polish-Swiss registered partnership, specializing in production of plastic profiles. For years we have been supplying innovative profiles in terms of shape, material and functionality for various industries, including furniture. Our offer of finishing profiles for furniture is rich both in terms of product and colour range.

We use highest quality plastics from proven suppliers for the production of furniture profiles. We extrude profiles with a weight of 15 g/m to 3500 g/m, using 24 modern production lines. In the final processing we use foiling, printing, stamping, drilling and bending.

ALL PRODUCTION PROCESSES ARE CERTIFIED ACCORDING TO **PN ISO 9001** STANDARD AND **ENVIRONMENTAL INSTRUCTION 1401**.



FURNITURE PROFILES

MODERN SOLUTIONS FOR FURNITURE INDUSTRY

// CONTENTS

SEALING PROFILES	4
AP 632 ANTI SILICON	5
COUNTERTOP SEALINGS	6
PLINTH SEALINGS	6
WALL SEAL PROFILES	7
MINI WAP CONCAVE AP 494	8
MINI WAP CONVEX AP 495	9
MINI WAP CONCAVE DECOR AP 636	10
WALL SEAL PROFILE AP 120	11
ALUMINIUM WALL SEAL PROFILE AP 121 A	10
ALUMINIUM COVER FOR WALL SEAL PROFILE AP 120 A	14
ITALO WAP AP 630	17
FURNITURE PLINTHS	19
CLASSIC AP 189	20
CLASSIC AP 637	20
FURNITURE SHUTTERS	22
SHUTTER AP 470	23
SHUTTER AP 270	23
READY MADE SETS – SIZE PER REQUEST AL 270	25
EDGE BANDING	27
PROFILES C AND T	32
PROFILE C - AP 088	33
PROFILE C - AP 167	33
PROFILE C - AP 353	34
PROFILE C - AP 384	34
PROFILE T - AP 155	35
PROFILE T - AP 153	35
PROFILE T - AP 156	35
PROFILES H, J	36
PROFILE H - AP 087	37
PROFILE H - AP 178	37
PROFILE J - AP 177	37
ALUMINIUM PROFILES	38
AL 104	39
AL 105	39
AL 107	39
AL 109	39
MARKETING MATERIALS	40
OTHER PRODUCTS	42
FENCE STRIPS	42
TECHNICAL PROFILES	43
CONTACT	44

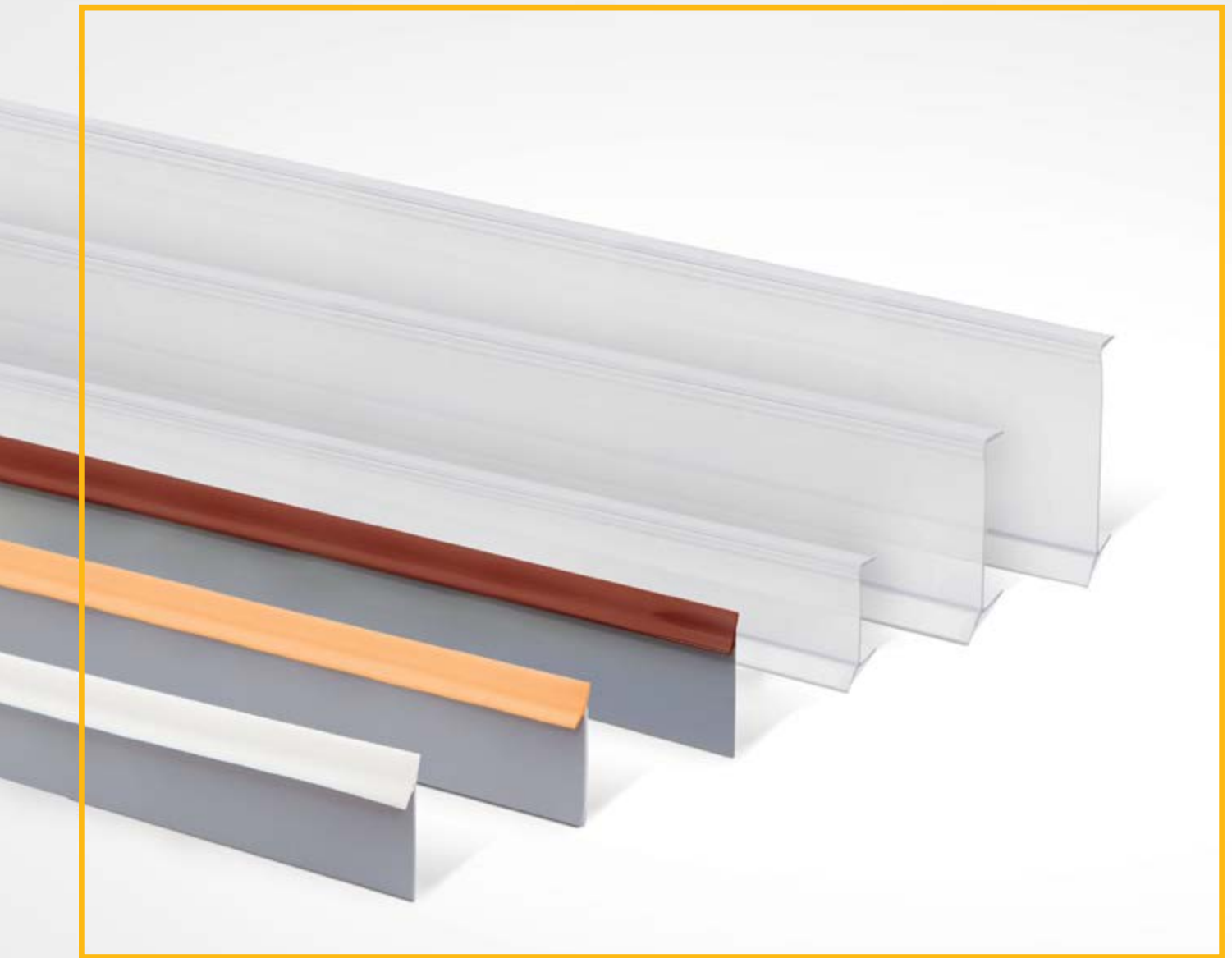

// SEALING PROFILES

Sealing strips are made of high quality PVC. Thanks to excellent sealing properties, strips have many applications. In our offer, we have profiles that are an alternative to silicone joints used to seal the worktop in your kitchen or bathroom ceramics elements, and sealing strips for furniture tops and plinths. Easy and quick asselmy of our sealing profiles is an additional benefit for customers.

**UNIVERSAL
APPLICATION** //



ANTI SILICON is a sealing profile that ideally fits the joining of perpendicular surfaces. A simple and quick way to finish the connections between kitchen worktop and wall or sink, bathtub and wall. Sealing used instead of silicone is water-proof and antibacterial.

Thanks to flexibility and small thickness of the tape (1 mm), the assembly of the sealing is extremely fast and easy, allowing to use the profile in narrow gaps. The sealing is available in colour suited to the range of silicone colours available on the market.

AP 632 ANTI SILICON			
PROFILE	INDEX	TECHNICAL DRAWING [MM]	PACKAGING
AP 632	632G.XXXXXK4200.00.00		1 pcs. x 4,2 lm

ANTI SILICON COLOUR RANGE

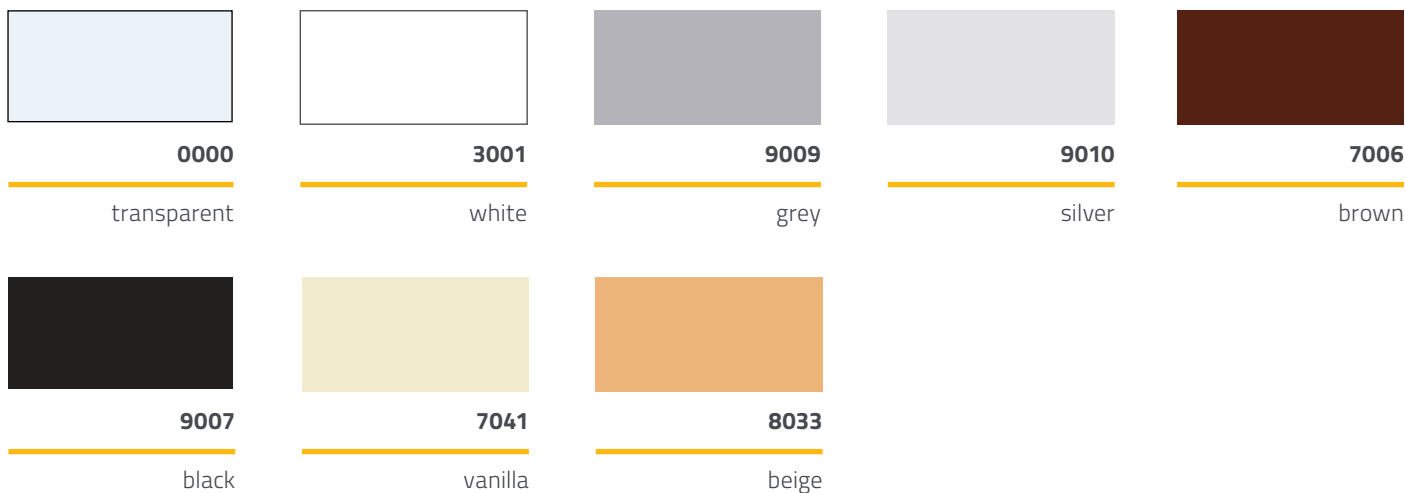

COUNTERTOP AND PLINTH SEALINGS



Sealings designed for countertops and under plinths effectively protect them against penetration of dirt and moisture. They are a discreet finish of gaps between top and wall, or plinth

and floor. Functionality, simple assembly and exceptional aesthetics are their main advantages.

COUNTERTOP SEALINGS

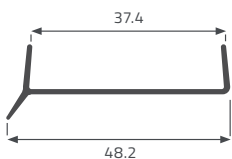
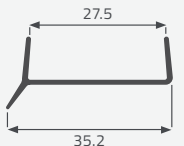
PROFILE	INDEX	CATALOGUE NAME	TECHNICAL DRAWING [MM]	PACKAGING
AP 268	268G.0000K3000.38.00	countertop sealing strip		20 pcs. x 3 lm
AP 269	269G.0000K3000.28.00	countertop sealing strip		20 pcs. x 3 lm

PLINTH SEALINGS

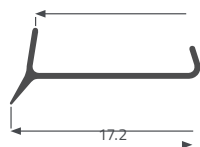
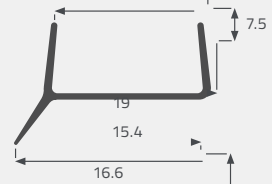
PROFILE	INDEX	CATALOGUE NAME	TECHNICAL DRAWING [MM]	PACKAGING
AP 659	659G.0000K3000.00.V2	plinth sealing strip 18 mm		50 pcs. x 3 lm
AP 241	241G.0000K3000.16.00	plinth sealing strip 16 mm		40 pcs. x 3 lm

COLOURS

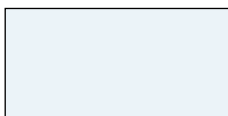

0000

transparent

All sealing strips for furniture tops and plinths are transparent.



// WALL SEAL PROFILES

Wall seal profiles are an aesthetic finish of the utility surface in your kitchen between wall and kitchen countertop. Construction of the wall seal profiles guarantees simple assembly and perfect adhesion of the profiles to the wall and countertop. Thermoplast has a wide range of wall seal profiles, together with finishing accessories (internal and external corners, end profiles). Profiles are made of best quality materials and allow customers to enjoy impeccable quality. Modern design and a wide range of colours will satisfy the tastes of the most demanding customers.

//
**AESTHETIC
FINISHING OF
YOUR KITCHEN**



MINI WAP SLATS

MINI WAP CONCAVE **AP 494**

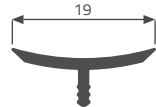
MINI WAP AP 494

PROFILE	INDEX	CATALOGUE NAME	IMAGE	TECHNICAL DRAWING [MM]	PACKAGING
AP 494	494V.xxxxx3000.00.KL	mini wap			32 pcs. x 3 m

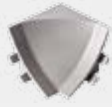
ACCESSORIES AP 494



PROFILE	INDEX	CATALOGUE NAME	IMAGE	PACKAGING
AK 494	494D.0XXX.AKZ	end profile		100 pcs.
AW 494	494D.0XXX.AWZ	internal corner		50 pcs.
AN 494	494D.0XXX.ANZ	external corner		50 pcs.

RANGE OF COLOURS **MINI WAP AP 494 AND ACCESSORIES**



accessories 201	accessories 202	accessories 203
		
201	202	203
white	black	aluminium

MINI WAP CONVEX AP 495



MINI WAP AP 495

PROFILE	INDEX	CATALOGUE NAME	IMAGE	TECHNICAL DRAWING [MM]	PACKAGING
AP 495	495V.xxxxx3000.00.KL	mini wap			20 pcs. x 3 m

AP 495 ACCESSORIES

PROFILE	INDEX	CATALOGUE NAME	IMAGE	PACKAGING
AK 495	495D.0XXX.AKZ	end profile		100 pcs.
AW 495	495D.0XXX.AWZ	internal corner		50 pcs.
AN 495	495D.0XXX.ANZ	external corner		50 pcs.

RANGE OF COLOURS **MINI WAP AP 495 AND ACCESSORIES**

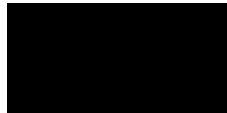
accessories 201	accessories 203	accessories 202
		
201	203	202
white	aluminium	black



MINI WAP CONCAVE DECOR **AP 636**

AP 636

PROFILE	INDEX	CATALOGUE NAME	IMAGE	TECHNICAL DRAWING [MM]	PACKAGING
AP 636	636V.xxxxx3000.00.KL	mini wap			10 pcs. x 3 m

ACCESSORIES DO AP 636

PROFILE	INDEX	CATALOGUE NAME	IMAGE	PACKAGING
AK 636	494D.0XXX.AKZ	end profile		100 pcs.
AW 636	494D.0XXX.AWZ	internal corner		50 pcs.
AN 636	494D.0XXX.ANZ	external corner		50 pcs.

RANGE OF COLOURS MINI WAP AP 636 AND ACCESSORIES

accessories 235	accessories 301	accessories 901	accessories 161
235	301	901	161
beige jute	white	black	silver





WALL SEAL PROFILE **AP 120**



Our wall seal profiles are an indispensable finishing part of every kitchen. Made from the finest materials, they let you enjoy impeccable quality for a long time. RANGE OF COLOURS perfectly matches decors of kitchen countertops of leading manufacturers in Poland.













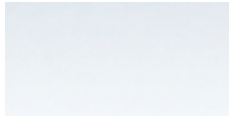











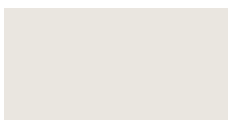

IDEAL MATCH!

AP 120

PROFILE	IMAGE	INDEX	CATALOGUE NAME	TECHNICAL DRAWING [MM]	PACKAGING
AP 120		120V.xxxxx.3000.00.00	wallseal profile		32 pcs. x 3 lm 10 pcs. x 3 lm*

RANGE OF COLOURS WALL SEAL AP 120 AND ACCESSORIES

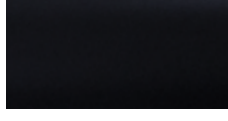
accessories 116	accessories 1007	accessories 909	accessories 1004	accessories 206
				
116	141	161	193	206
beech	alder	silver	light marble	wenge

<p>accessories 235</p>  <p>235</p> <p>juta beige</p>	<p>accessories 284</p>  <p>284</p> <p>konsuela</p>	<p>accessories 703</p>  <p>285</p> <p>golden granite</p>	<p>accessories 301</p>  <p>301</p> <p>white</p>	<p>accessories 706</p>  <p>326</p> <p>dark walnut</p>
<p>accessories 816</p>  <p>404</p> <p>light beech</p>	<p>accessories 708</p>  <p>571</p> <p>light oak</p>	<p>accessories 841</p>  <p>841</p> <p>champagne</p>	<p>accessories 901</p>  <p>901</p> <p>black</p>	<p>accessories 580</p>  <p>1004</p> <p>sand chip</p>
<p>accessories 308</p>  <p>1515</p> <p>bianka</p>	<p>accessories 901</p>  <p>1519</p> <p>dolores</p>	<p>accessories 909</p>  <p>820</p> <p>silver matt</p>	<p>accessories 1105</p>  <p>1105</p> <p>white gloss</p>	<p>accessories 1905</p>  <p>1905</p> <p>black gloss</p>
<p>accessories 1514</p>  <p>1249</p> <p>light travertine</p>	<p>accessories 591</p>  <p>0785</p> <p>jasmine</p>	<p>accessories 1905</p>  <p>1251</p> <p>andromeda</p>	<p>accessories 1511</p>  <p>1245</p> <p>sonoma oak</p>	<p>accessories 500</p>  <p>1253</p> <p>siena oak</p>
<p>accessories 901 *</p>  <p>1314</p> <p>diamond black</p>	<p>accessories 116 *</p>  <p>1356</p> <p>retro wood</p>	<p>accessories 1105 *</p>  <p>1357</p> <p>andromeda white II</p>	<p>accessories 1358f *</p>  <p>1358</p> <p>canyon oak</p>	<p>accessories 284 *</p>  <p>1533</p> <p>tassili dark</p>
<p>accessories 903 *</p>  <p>1534</p> <p>atelier light</p>	<p>accessories 284 *</p>  <p>1536</p> <p>concrete</p>	<p>accessories 1910</p>  <p>1910</p> <p>black</p>	<p>accessories 899</p>  <p>899</p> <p>graphite</p>	<p>accessories 1110</p>  <p>1110</p> <p>white matt</p>

accessories 1398



1398

oak forever



accessories 1387



1387

dąb wotan

AP 120 ACCESSORIES

PROFILE	INDEX	CATALOGUE NAME	IMAGE	PACKAGING
AW 120	120D.OXXX.AW	internal corner		25 pcs.
AN 120	120D.OXXX.AN	external corner		25 pcs.
AK 120	120D.OXXX.AK	end profile		25 pcs.



ALUMINIUM WALL SEAL PROFILE **AP 121 A**

Wall seal profile has the advantages of a traditional countertop wall seal profile and an aluminum cover. The main advantages of the profile are resistance to deformation under the influence of high temperatures and easy and quick assembly.



AP 121 A

PROFILE	INDEX	CATALOGUE NAME	IMAGE	TECHNICAL DRAWING [MM]	PACKAGING
AP 121 A	121A.xxxxx.3000.00AL	aluminium wall seal profile			10 pcs. x 3 lm

RANGE OF COLOURS **AP 121 A AND ACCESSORIES**

accessories 841	accessories 830	accessories 1105	accessories 1905	accessories 901
OC30S	OC000A	9016	9005	C35AN
inox brushed	anoda silver	white gloss	black gloss	anoda black

ACCESSORIES AP 121 A

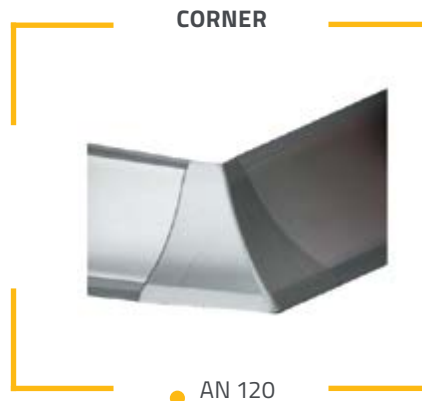
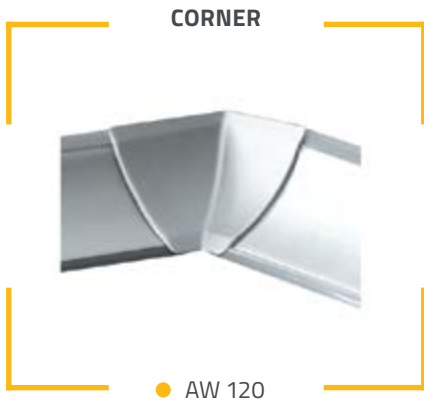

PROFILE	INDEX	CATALOGUE NAME	IMAGE	PACKAGING
AW 120	120D.OXXX.AW	internal corner		25 pcs.
AN 120	120D.OXXX.AN	external corner		25 pcs.
AK 120	120D.OXXX.AK	end profile		25 pcs.





ALUMINIUM COVER FOR WALL SEAL PROFILE **AP 120 A**

AP 120 A

PROFILE	INDEX	CATALOGUE NAME	IMAGE	TECHNICAL DRAWING [MM]	PACKAGING
AP 120 A	120A.xxxxx0800.00.AL	aluminium cover			1 pcs. x 0,8 lm

RANGE OF COLOURS **AP 120 A**



OC30S

inox brushed



OC00A

anoda silver



110S

white gloss



190S

black gloss



C35AN

anoda black

Innovative aluminium cover is a reliable protection of the profile. It protects against deformation under the influence of high temperatures. Cover does not require gluing or additional joints.



WALL SEAL PROFILE **ITALO WAP**





The ITALO WAP wall seal profile is a harmony of functionality and beauty. It has been made of durable, foamed PVC, and has gaskets to protect against dirt and moisture. Cutting corners is as simple as with wooden slats. Perfect bonding with glue or silicone. Profile can also be finished with dedicated corners and end profiles.

SUBTLE FINISHING

ITALO WAP AP 630

PROFILE	INDEX	CATALOGUE NAME	IMAGE	TECHNICAL DRAWING [MM]	PACKAGING
AP 630	630B.xxxxx3000.00.KP	italo wap			8 pcs. x 3 lm

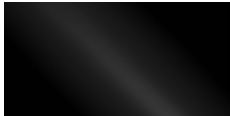
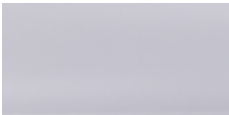
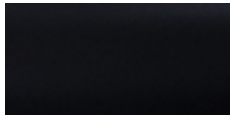

RANGE OF COLOURS ITALO WAP AND ACCESSORIES

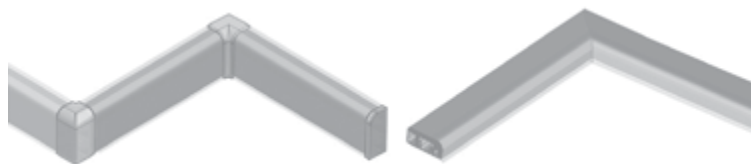
<p>accessories 1208</p>  <p>1208 inox</p>	<p>accessories 1105</p>  <p>1105 white gloss</p>	<p>accessories 1905</p>  <p>1905 black gloss</p>	<p>dodatki 1110</p>  <p>1110 biały mat</p>	<p>dodatki 1910</p>  <p>1910 czarny mat</p>
<p>dodatki 1209</p>  <p>1209 aluflex</p>	<p>dodatki 1536</p>  <p>1536 beton</p>			



POSSIBILITY OF USING PROFILES IN A VERTICAL AND HORIZONTAL POSITION

ITALO WAP AP 630 ACCESSORIES

PROFILE	INDEX	CATALOGUE NAME	IMAGE	PACKAGING
AW 630	630D.XXXX.AW	internal corner		5 pcs.
AN 630	630D.XXXX.AN	external corner		5 pcs.
AK 630	630D.XXXX.AK	end profile		5 sets. (5 pcs.left end profiles + 5 pcs.right end profiles)
SET	630D.XXXX.SET	set AW, AN, AK		sets 1 pceach.

EXCLUSIVE COLLECTION OF INOX FINISHING PROFILES





// FURNITURE PLINTHS

MODERN SLIM plinths are intended for elastic finishing of kitchen cabinets. Their presence in your kitchen is a step towards novelty and elegance. Thanks to our plinths, you will easily maintain cleanliness and tidiness beneath your kitchen furniture!

**FUNCTIONALITY
AND ELEGANCE** //

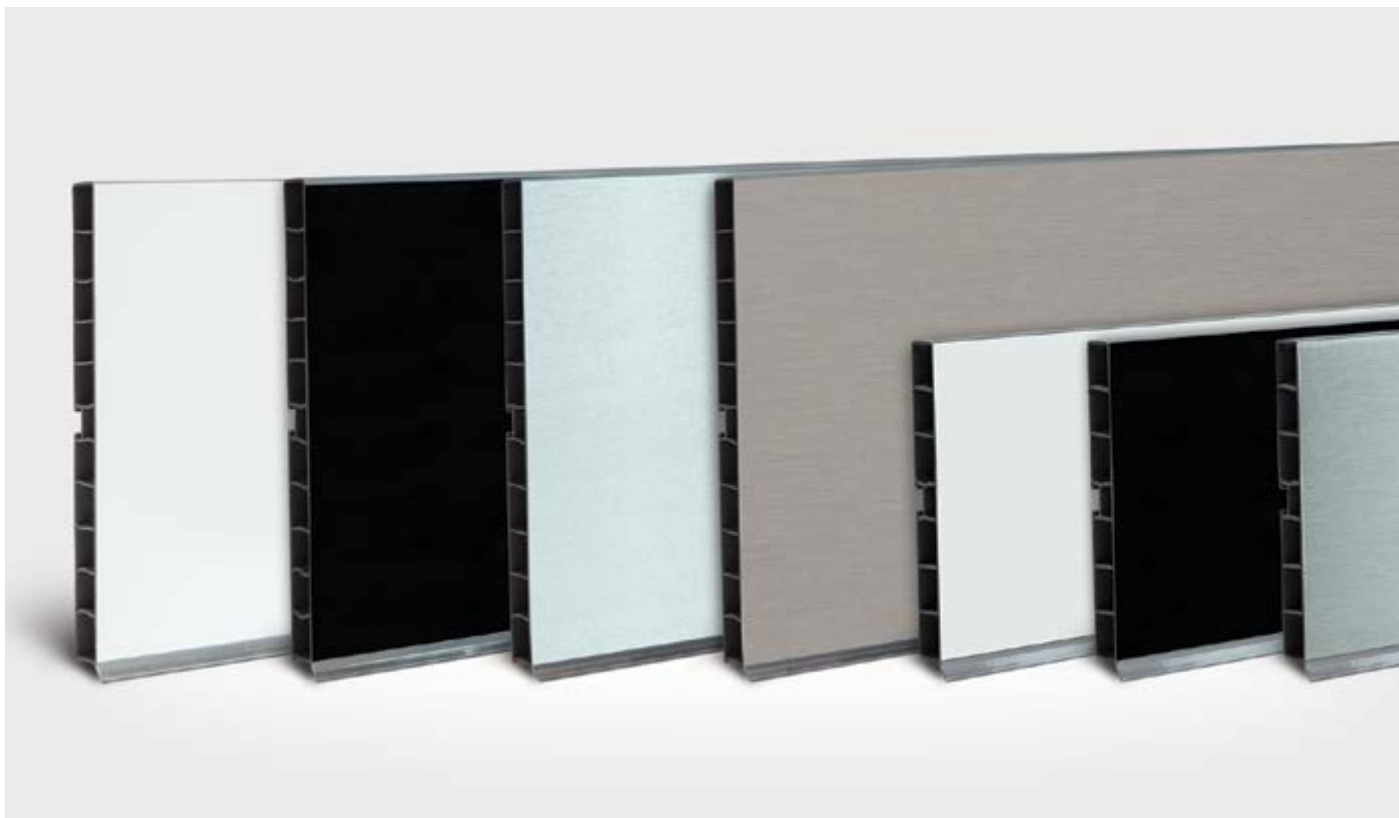

FURNITURE PLINTH **CLASSIC**

PROVEN AND RELIABLE FINISHING OF KITCHEN FURNITURE

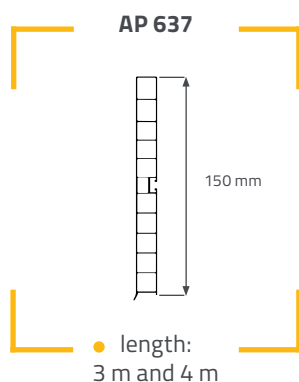
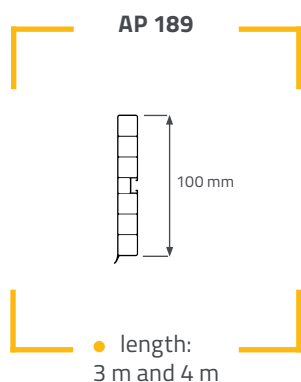

CLASSIC PLINTHS

PROFILE	INDEX	CATALOGUE NAME	PACKAGING
AP 189	189B.XXXXXA.XXX.XX	plinth 100	10 pcs. x 3 m
AP 637	637B.XXXXXA.XXX.XX	plinth 150	10 pcs. x 3 m

CLASSIC PLINTHS COLOUR RANGE



1105

white gloss



1905

black gloss



820

silver matt



1110

biały mat

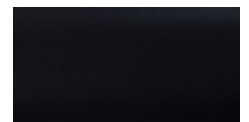

1910

czarny mat



1209

aluflex



1536

beton

ACCESSORIES IN PLINTH'S COLOUR



● end profile



● multi-corner



● mounting clip

CLASSIC PLINTH ACCESSORIES

PROFILE	INDEX	CATALOGUE NAME	PACKAGING
APK 189	189D.XXXX.APK	end profile	25 pcs.
APK 637	637D.XXXX.APK	end profile	25 pcs.
AMC 189	189D.XXXX.AMC	multi-corner	10 pcs.
AMC 637	189D.XXXX.AMC	multi-corner	10 pcs.
ADM189/637	189D.0300.K	mounting clip	100 pcs.



// FURNITURE SHUTTERS

They replace traditional furniture fronts not only in kitchen and office cabinets. This solution can also be found in workshops, supermarkets, specialist cars, campers, yachts. Fast and easy assembly and express implementation is the reason for the popularity of this solution in the furniture industry. The shutters made by Thermoplast are made of high quality plastic or aluminium. Available in a wide range of colours, they satisfy the tastes of the most demanding customers.

//
**OPTIMAL
USE OF SURFACE**



SHUTTER AP 470

TECHNICAL
DRAWING

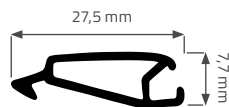

• AP 470

SHUTTER AP 270

TECHNICAL
DRAWING

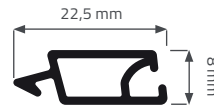

• AP 270

RANGE OF COLOURS AP 470



MT 470 - 161

silver

RANGE OF COLOURS AP 270



MR 270 - 820

silvermatt



MR 270 - 1105

white



MR 270 - 1905

black

SHUTTERS AVAILABLE IN:

- ready-made sets, which guarantees quick and easy assembly
- profiles, which is a favorable offer for manufacturers expecting the lowest cost calculation and non-standard solutions



PVC FURNITURE SHUTTERS



**excellent
price-quality
ratio**



**innovative
technical
solutions**

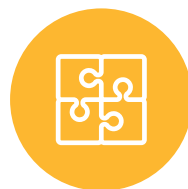

**fast and easy
to assemble**



**wide range
of colours**

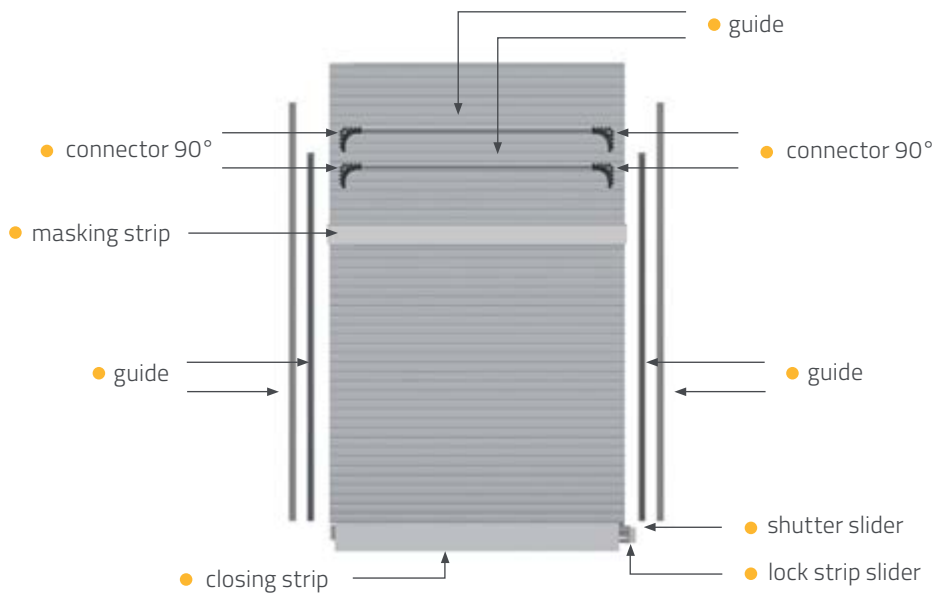

**SHUTTER SYSTEM
IN FURNITURE FRAME**

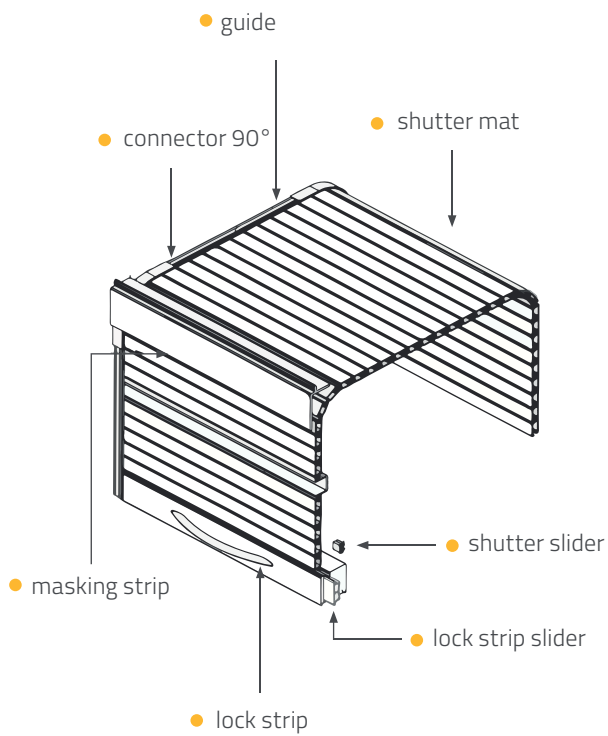



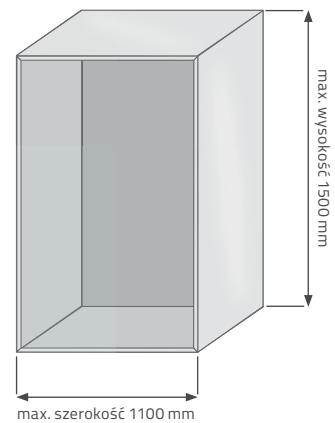





**MAX. DIMENSIONS
OF THE FRAME**



In order to meet the clients' demand for ready-made sets of furniture blinds, our company makes them for any size up to 1500 mm in height and 1100 mm in width.

FURNITURE SHUTTERS IN PROFILES FOR INDIVIDUAL CUT TO SIZE

PROFILE	INDEX	CATALOGUE NAME	IMAGE	PROFILE CROSS SECTION	PACKAGING AND COLOUR
MR 270	270Z.xxxxF2600.00.00	shutter profile			45 pcs. x 2,6 lm colours: 820, 1105, 1905
MT 470	470Z.xxxxT2600.00.00	shutter profile			40 pcs. x 2,6 lm colours: 116, 141, 161, 076, 097
AP 271	271Z.xxxxK2600.00.00	internal guide			14 pcs. x 2,6 lm colours: 301, 901, 909, 832, 816, 740
AP 272	272Z.xxxxK2600.00.00	external guide + base			14 pcs. x 2,6 lm colours: 909, 301, 901, 816, 832, 740, 830
MR 276 MT 276	276Z.xxxxx2600.00.00	lock strip profile			3 pcs. x 2,6 lm colours: 820, 1105, 1905, 116, 141, 161, 076, 097
MR 277	277Z.xxxxF2600.00.00	lock strip profile			3 pcs. x 2,6 lm colours: 820, 1105, 1905
MR 713	713Z.xxxxT2600.00.00	masking strip profile			6 pcs. x 2,6 lm colours: 820, 1105, 1905, 116, 141, 161, 076, 097
AZ 270 AZ 470	270D.0000.AZ 470D.0000.AZ 710D.0000.AZZ	shutter slider profile			100 pcs. colours: transparent
AZ 271	271D.0xxx.AZ	internal arc 90° for a guide AP 271			10 pcs. colours: 301, 901, 909, 832, 816, 740
AZ 273	273D.0xxx.AZ	external arc 90° for a guide AP 272			10 pcs. colours: 301, 901, 909, 832, 816, 740
AZ 277	277D.0xxx.AZ	lock strip slider			10 pcs. colours: 301, 901, 909, 832, 816, 740

2 LOCK TYPES FOR PROFILES MR/MT 276, MR 712

VERTI LOCK

insert
ø 18 mm x 32 mm



HUWIL LOCK

insert
ø 16,5 mm x 22 mm





// EDGE BANDING

Edge bandings are necessary as finishing elements of furniture, which have a decisive impact on their aesthetics, durability and functionality. Their task is to finish the raw edges of furniture boards. Their colours, structure and gloss are selected in terms of a particular furniture board. In our offer, PVC edge bandings come in a wide range of colours and sizes for both the carpentry market and furniture industry.

EXQUISITE
FINISHING //



EDGE BANDING			
PROFILE	INDEX	CATALOGUE NAME	PACKAGING
AP 374 22 X 0,6 (MM)	374TXXXXX.250.22.0	PVC edge banding	6 x 250 lm
AP 376 22 X 1 (MM)	376TXXXXX.150.22.0	PVC edge banding	6 x 150 lm
AP 377 22 X 2 (MM)	377TXXXXX.100.22.0	PVC edge banding	6 x 100 lm
AP 377 32 X 2 (MM)	377TXXXXX.100.33.0	PVC edge banding	4 x 100 lm
AP 214 42 X 2 (MM)	214TXXXXX.050.42.0	PVC edge banding	1 x 50 lm

EDGE BANDING SIZES

Width (mm)*	THICKNESS (mm)	0,6	1,0	2,0
	22		●	●
33				●
42				●

* We make edges in non-standard widths, e.g. 16 mm, 19 mm, 25 mm, 28 mm, 66 mm on request.

EDGE BANDING RANGE OF COLOURS



3310 P

prega white
K110



3301

smooth white
K110



3322

alaska white
U8681SM



3108

vanilla
U108



3841

vanilla
U1313



3858

sandy
U515

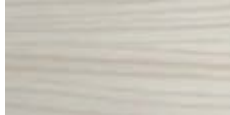

3533

navarra
R4524

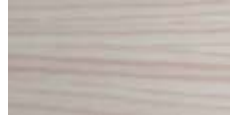

3534

werona ash
D3158WG



3219

white maple
D2460

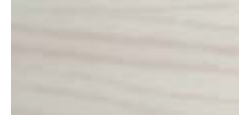

3053

birch
H1733



3535

white rieka oak
D3166MX

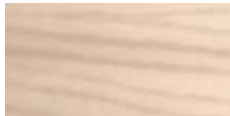

3123

milky oak
R4120

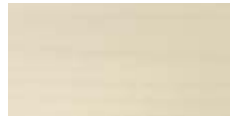

3524

honey maple
H1521



3066

vancouver maple
D440



3063

maple
D375



3221

light wenge
D2427

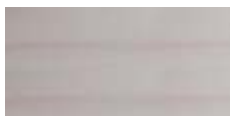

3087

field pear tree
D664



3245

alaska birch
R5717

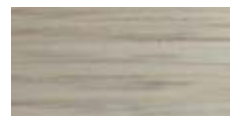

3361

light palermo oak
D2609



3519

stone pine avola
H1476



3278

sandy zebrano
H3006



3220

seagrass
D2298

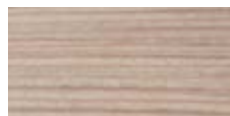

3247

light legno
R3083



3188

light swiss pine
D2381

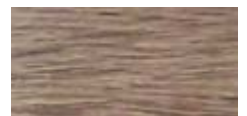

3530

sonora oak
D3025



3083

mangfal beech
R5107



0120

multiplex



3067

beech
D381, R5113



3104

light locarno apple tree
D9475



3523

natural oak
H3389

EDGE BANDING RANGE OF COLOURS



3526

urbano
H3070



3266

olive
D2715



3112

mountain oak
D740, 740KS



3061

alder



3191

brown fino
F583



3057

rigoletto
D8417



3536

tabac sonoma oak
D5194MX



3783

cappuccino
U3053PE



3051

grey
U2101



0820

matt silver



3117

silver
D881



3942

anthracite
U1290



3942

graphite
U3114PE



3068

bavarian beech
D1426, D9200



3193

mountain alder
R4634



3522

cherry
H1706



3069

cherry
D D088



3062

alder
D9310



3294

alder

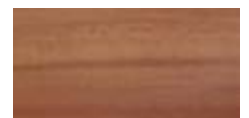

3520

merano
H3128



3248

legno tabac
R3248



3517

beige-grey zebrano
H3005



3225

acacia
R5717

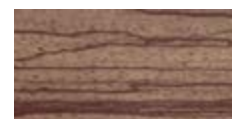

3217

african zebrano
D2296



3052

havana nova
8956KS



3527

merano brown
H3129



3226

toscany nut
D2453



3074

white nut
D722, R4842



3122

calvados
D1937



3165

field peartree
D9300, R4964

EDGE BANDING RANGE OF COLOURS



3072

locarno apple tree
D1972



3075

bologna nut
D9451



3056

plum
D2608



3167

wild pear tree
R4967



3078

red mahogany
D775SE

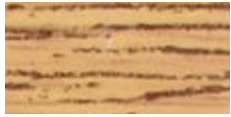

3114

rustic oak
D708



3222

dark zebrano
D2297



3058

ecco nut
D9459



3186

corsico chestnut
R4118



3059

nut
1925KS



3218

macassar
D2446

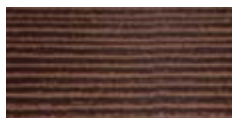

3054

wenge
D2227



3079

togo mahogany
D466



3298

tirol beech
H1599



3055

dark parelmo oak
D2610

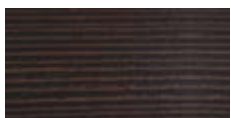

3189

chocolate swiss pine
D2380



3076

dark nut
D9450



3050

zebrano
D9775



3187

wenge chestnut



3160

magic wenge



3288

ferrara oak
H1137



3901

black
U2200



← colour visualisation
 ← colour visualisation
3526 ← colour name by catalogue
 urbano ← index of the board
 H3070 ← manufacturer and board colour

It is possible to individually choose the colour and size of edges to the latest trends in the design of boards and countertops.





// PROFILES C AND T

C and T profiles have long been one of the best methods of finishing furniture. Thanks to the use of high quality materials, our C and T profiles are extremely resistant to abrasion and impact, which protects the furniture panels against damage during operation. It is a simple and aesthetic finish of furniture, tables or countertops.

TIMELESS SOLUTION //



PROFILE C - AP 088

PROFILE	DESCRIPTION	TECHNICAL DRAWING [MM]	PACKAGING
AP 088	soft PVC profile		2 pcs. x 35 lm

RANGE OF COLOURS **AP 088**



3001
white



9007
black

On customer's request, there is a possibility of individual colour selection.

PROFILE C - AP 167*

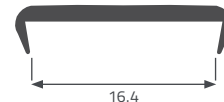
PROFILE	DESCRIPTION	TECHNICAL DRAWING [MM]	PACKAGING
AP 167	softPVC profile		2 pcs. x 35 lm

* This profile is manufactured to customer's order. There is a possibility of individual colour selection.

PROFILE C - AP 353*

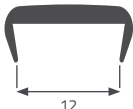
PROFILE	DESCRIPTION	TECHNICAL DRAWING [MM]	PACKAGING
AP 353	soft PVC profile		2 pcs. x 35 lm

* This profile is manufactured to customer's order. There is a possibility of individual colour selection.

PROFILE C - AP 384

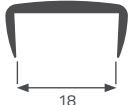
PROFILE	DESCRIPTION	TECHNICAL DRAWING [MM]	PACKAGING
AP 384	hard PVC profile		20 pcs. x 2,6 lm

RANGE OF COLOURS AP 384



3001

white

On customer's request, there is a possibility of individual colour selection.

Functionality and ease of installation of our profiles, without the use of expensive, specialized machinery, makes that both furniture-makers, as well as private users, often reach for them to raise the aesthetics of furniture.

PROFILE T

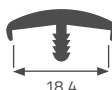

PROFILE T - AP 155

PROFILE	DESCRIPTION	TECHNICAL DRAWING [MM]	PACKAGING
AP 155	hard PVC profile		1 pcs. x 35 lm

RANGE OF COLOURS AP 155



3001

white

PROFILE T - AP 153 *

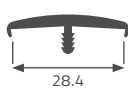
PROFILE	DESCRIPTION	TECHNICAL DRAWING [MM]	PACKAGING
AP 153	soft PVC profile		1 pcs. x 35 lm

* This profile is manufactured to the customer's order.

PROFILE T - AP 156 *

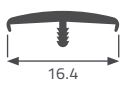
PROFILE	DESCRIPTION	TECHNICAL DRAWING [MM]	PACKAGING
AP 156	soft PVC profile		1 pcs. x 35 lm

* This profile is manufactured to the customer's order.

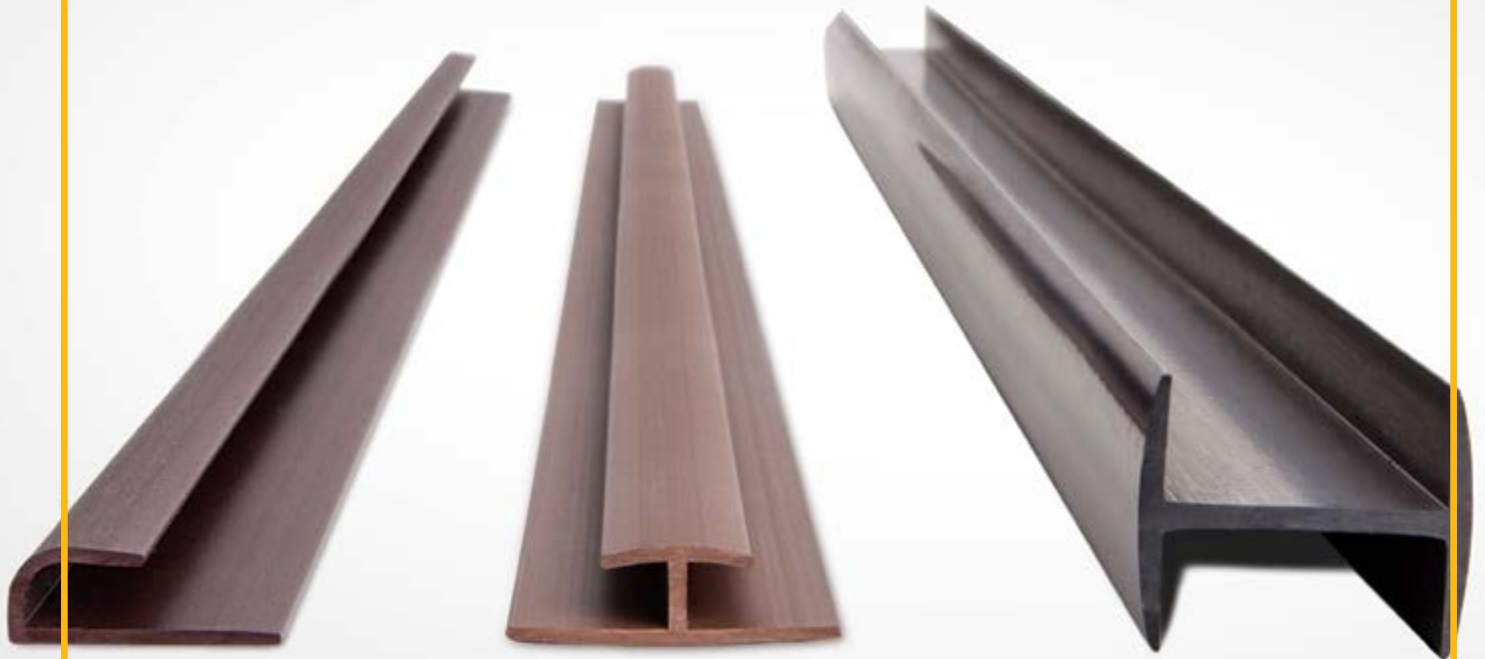



// PROFILES H, J

This group of profiles includes structural profiles for joining and securing furniture boards, H and J. Profiles of this type allow for aesthetic connection of two boards in one plane with a very gentle transition from one to the other. With these profiles, simple assembly eliminates the imperfections of traditional panel joining.

//
**AESTHETIC
AND EASY
ASSEMBLY**

PROFILE H - AP 087

PROFILE	INDEX	DESCRIPTION	IMAGE	TECHNICAL DRAWING [MM]	PACKAGING
AP 087	087I.0000K2600.18.20	used for joining two boards (18 mm) in one plate			20 pcs. x 2,6 lm

RANGE OF COLOURS AP 087



301

white

On customer's request, there is a possibility of individual colour selection.

PROFILE H - AP 178

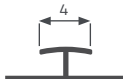
PROFILE	INDEX	DESCRIPTION	IMAGE	TECHNICAL DRAWING [MM]	PACKAGING
AP 178	178L.0000K2600.00.20	used for joining two boards (4 mm) in one plate			20 pcs. x 2,6 lm

RANGE OF COLOURS AP 178







301

white

On customer's request, there is a possibility of individual colour selection.

PROFILE J - AP 177

PROFILE	INDEX	DESCRIPTION	IMAGE	TECHNICAL DRAWING [MM]	PACKAGING
AP 177	177I.0000K2600.00.20	used for finishing 4 mm boards			20 pcs. x 2,6 lm
AP 177	177I.0301K2600.00.00	used for finishing 4 mm boards			100 pcs. x 2,6 lm

RANGE OF COLOURS AP 177



301

white



901

black

On customer's request, there is a possibility of individual colour selection.









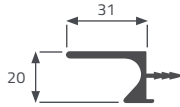

// ALUMINIUM PROFILES

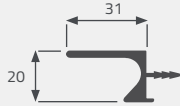
Aluminium profiles in our offer are used as handles mounted to furniture fronts. Their durability, universal application, modern design and availability meet the high requirements of customers. Our handle profiles have gained recognition for quality and have been recognized for their colouristic repeatability. The current collection is systematically extended with the most popular solutions on the market.

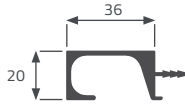
MODERN //
DESIGN

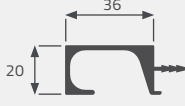
ALUMINIUM HANDLE PROFILES

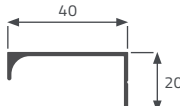
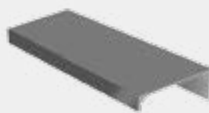
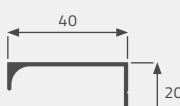
PROFILE	INDEX	IMAGE	TECHNICAL DRAWING [MM]	COLOUR	PACKAGING
AL 105	AL105KW.0C30S3000.PK			inox (0C30S)	10 pcs. x 3 lm
AL 105	AL105KW.0C00A3000.PK			anoda silver (0C00A)	10 pcs. x 3 lm
AL 107	AL107KW.0C30S3000.PK			inox (0C30S)	10 pcs. x 3 lm
AL 107	AL107KW.0C00A3000.PK			anoda silver (0C00A)	10 pcs. x 3 lm
AL 109	AL109KW.0C30S3000.PK			inox (0C30S)	10 pcs. x 3 lm
AL 109	AL109KW.0C00A3000.PK			anoda silver (0C00A)	10 pcs. x 3 lm

ALUMINIUM PROFILES RANGE OF COLOURS



0C00A

anodasilver



0C30S

inox

* Range of colours in the catalogue may slightly differ from actual colours.

// MARKETING MATERIALS

In order to meet the expectations of our contractors, and to facilitate display and sale of Thermoplast products, we give full marketing support in the form of various advertising materials, templates, displays, stands, discount actions, bonus schedules, promotions in media and trade fairs.

Thanks to this, all information about our products is easily available, which makes easier to make a decision about purchasing our profiles

STANDS, TEMPLATES



BANNERS



LEAFLEATS, POSTERS, FOLDERS, MAILINGS



SAMPLE CHARTS, ROLL-UPS



MARKETING GADGETS



PROMOTIONS, BONUS SCHEDULES



PROFFESIONAL PRODUCT-SALE TRAININGS

*We want to support you
- Thermoplast employees.*

OTHER PRODUCTS

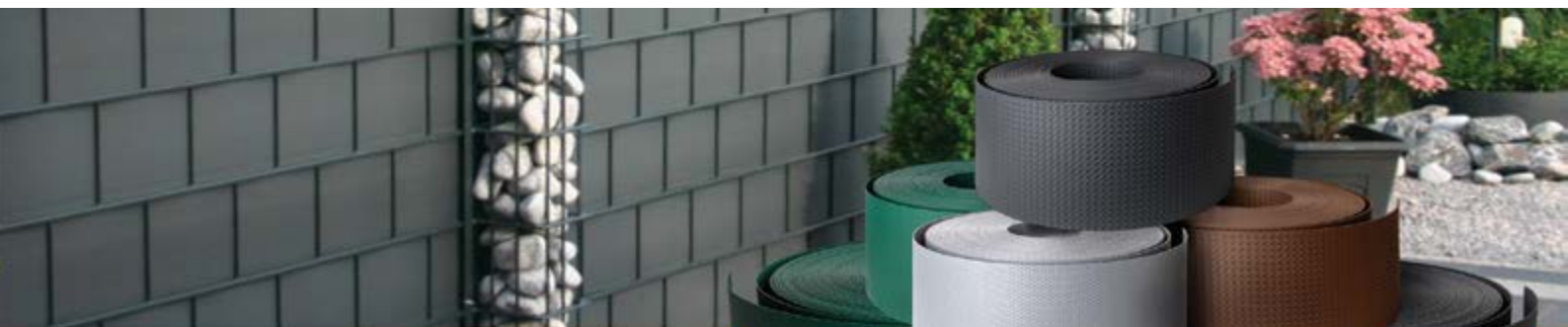

GUARANTEED COVER AND
PRIVACY FOR PROPERTIES,
TERRACES AND BALCONIES

// FENCE STRIPS

Fence strips are an innovative solution that allows you to create modern, aesthetic and functional fencing systems for people, who want to keep their privacy on their property, in the garden or at the balcony.

PATTERNS



BASIC



CLASSIC LINE



ORANGE SKIN



TECHNO RATTAN
I



TECHNO RATTAN
II

IDEAL FOR:



MESH WIRE FENCING



BALCONY RAILINGS



CHAIN LINK FENCES

SIZES



190 mm

1 box	26 lm
1 m ²	5 lm
1 box	5 m ²



95 mm

1 box	52 lm
1 m ²	10 lm
1 box	5 m ²



47,5 mm

1 box	50 lm
1 m ²	20 lm
1 box	2,5 m ²

END CLIPS



Esthetic clip for fixing
strips to a panel.

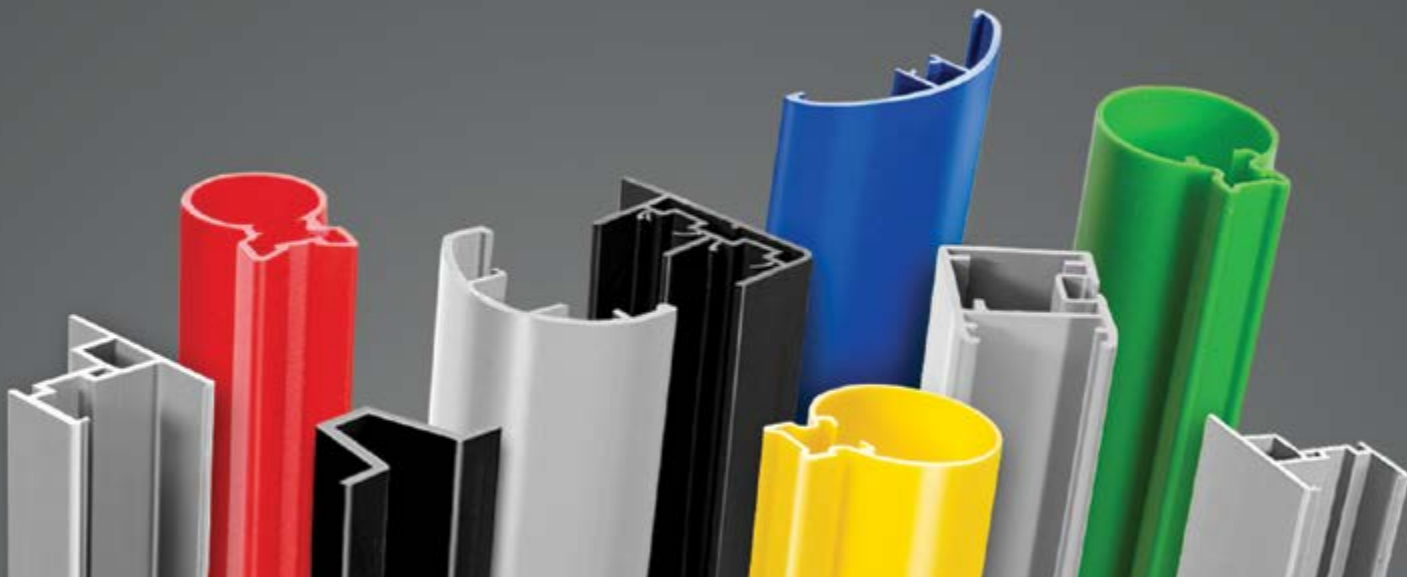

// TECHNICAL PROFILES

We specialize in designing and building tools for extrusion, and in extrusion technology of profiles, which meet the expectations of individual investors from various industries.

IMPLEMENTATION OF INDIVIDUAL PROJECTS

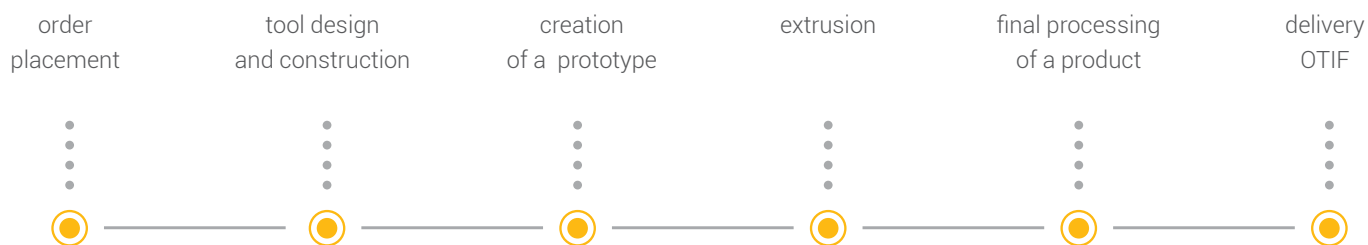

WIDE APPLICATION OF PROFILES IN INDUSTRIES

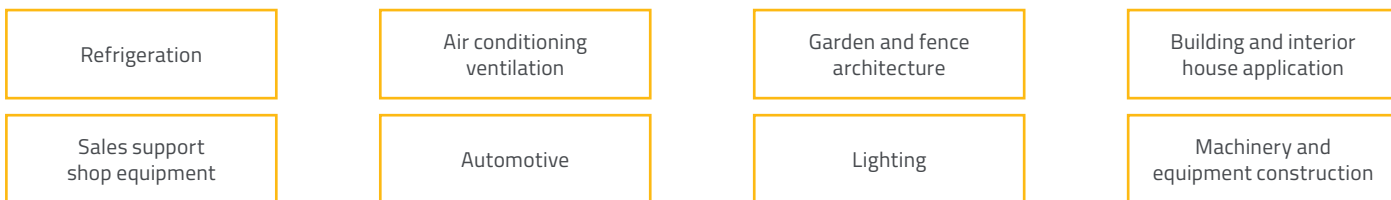

TECHNICAL PROFILES CATALOGUES





// CONTACT

Thermoplast Technology P.S.A.
ul. Wilcza 3
32-590 Libiąż
www.thermoplast.eu

SALES DEPARTMENT:
Tel: +48 32 625 86 36
Mobile: +48 669 121 610
E-mail: export@thermoplast.eu

OFFICE:
Tel: +48 32 627 19 82
Fax: +48 32 623 13 64
Fax: +48 32 623 06 78
E-mail: biuro@thermoplast.eu

**FEEL FREE TO CONTACT US!
WE SPEAK YOUR LANGUAGE!**



WWW.THERMOPLAST.EU