

FURNITURE PROFILES **CATALOGUE**



 **Thermoplast**[®]

www.thermoplast.eu



Thermoplast was established in Poland in 1989 as a Polish-Swiss registered partnership, specializing in production of plastic profiles. For years we have been supplying innovative profiles in terms of shape, material and functionality for various industries, including furniture. Our offer of finishing profiles for furniture is rich both in terms of product and colour range.

We use highest quality plastics from proven suppliers for the production of furniture profiles. We extrude profiles with a weight of 15 g/m to 3500 g/m, using 24 modern production lines. In the final processing we use foiling, printing, stamping, drilling and bending.

ALL PRODUCTION PROCESSES ARE CERTIFIED ACCORDING TO PN ISO 9001 STANDARD AND ENVIRONMENTAL INSTRUCTION 1401.



FURNITURE PROFILES

MODERN SOLUTIONS FOR FURNITURE INDUSTRY

// CONTENTS

SEALING PROFILES	4
AP 632 ANTI SILICON	5
COUNTERTOP SEALINGS	6
PLINTH SEALINGS	6
WALL SEAL PROFILES	7
MINI WAP CONCAVE AP 494	8
MINI WAP CONVEX AP 495	9
MINI WAP CONCAVE DECOR AP 636	10
WALL SEAL PROFILE AP 120	11
ALUMINIUM WALL SEAL PROFILE AP 121 A	10
ALUMINIUM COVER FOR WALL SEAL PROFILE AP 120 A	14
ITALO WAP AP 630	17
FURNITURE PLINTHS	19
CLASSIC AP 189	20
CLASSIC AP 637	20
FURNITURE SHUTTERS	22
SHUTTER AP 470	23
SHUTTER AP 270	23
READY MADE SETS – SIZE PER REQUEST AL 270	25
EDGE BANDING	27
PROFILES C AND T	32
PROFILE C - AP 088	33
PROFILE C - AP 167	33
PROFILE C - AP 353	34
PROFILE C - AP 384	34
PROFILE T - AP 155	35
PROFILE T - AP 153	35
PROFILE T - AP 156	35
PROFILES H, J	36
PROFILE H - AP 087	37
PROFILE H - AP 178	37
PROFILE J - AP 177	37
ALUMINIUM PROFILES	38
AL 104	39
AL 105	39
AL 107	39
AL 109	39
MARKETING MATERIALS	40
OTHER PRODUCTS	42
FENCE STRIPS	42
TECHNICAL PROFILES	43
CONTACT	44

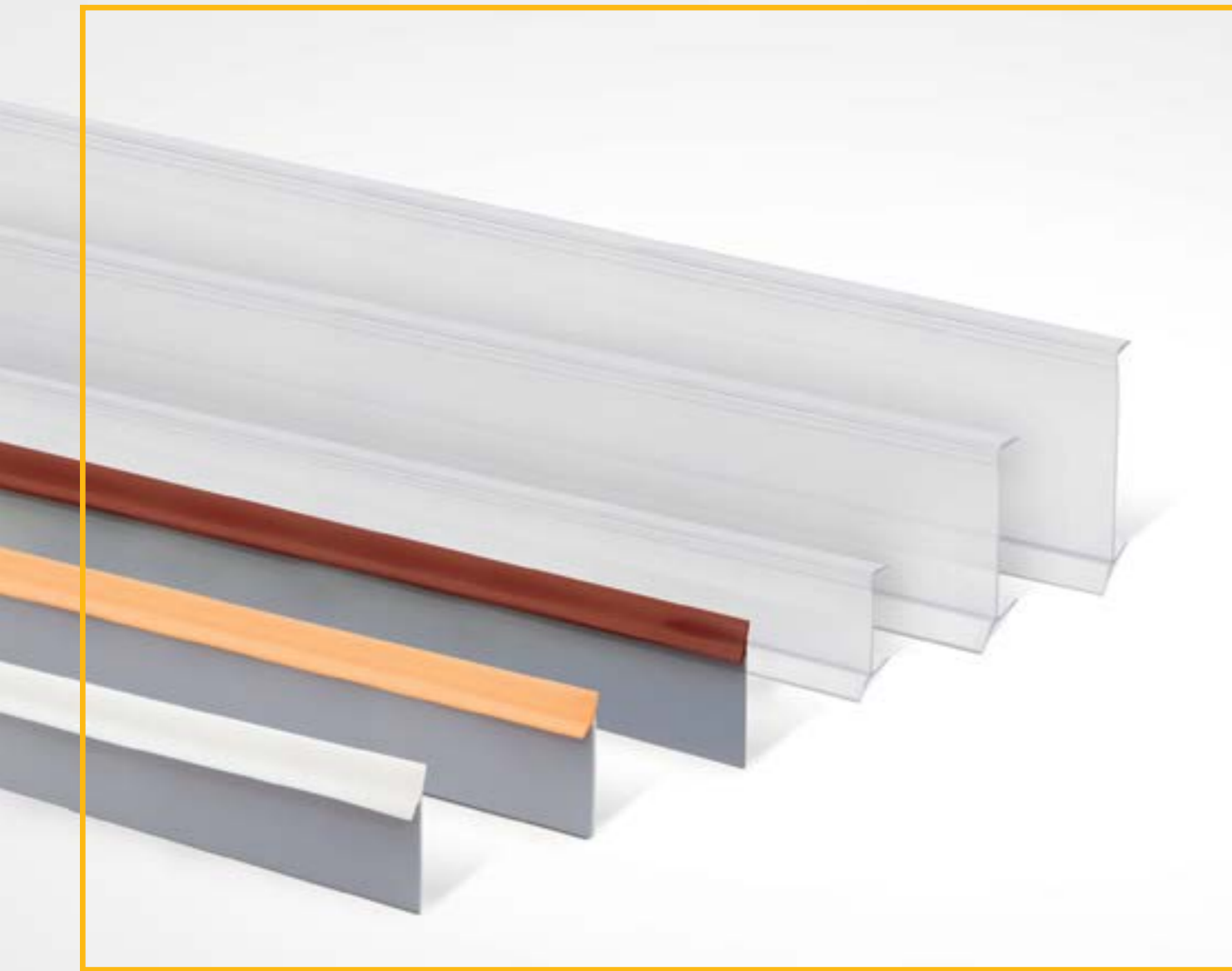

AP 632 ANTI SILICON



ANTI SILICON is a sealing profile that ideally fits the joining of perpendicular surfaces. A simple and quick way to finish the connections between kitchen worktop and wall or sink, bathtub and wall. Sealing used instead of silicone is waterproof and antibacterial.

Thanks to flexibility and small thickness of the tape (1 mm), the assembly of the sealing is extremely fast and easy, allowing to use the profile in narrow gaps. The sealing is available in colour suited to the range of silicone colours available on the market.

AP 632 ANTI SILICON

PROFILE	INDEX	TECHNICAL DRAWING [MM]	PACKAGING
AP 632	632G.XXXXK4200.00.00		1 pcs. x 4,2 lm

// SEALING PROFILES

Sealing strips are made of high quality PVC. Thanks to excellent sealing properties, strips have many applications. In our offer, we have profiles that are an alternative to silicone joints used to seal the worktop in your kitchen or bathroom ceramics elements, and sealing strips for furniture tops and plinths. Easy and quick assembly of our sealing profiles is an additional benefit for customers.

UNIVERSAL APPLICATION //

ANTI SILICON COLOUR RANGE

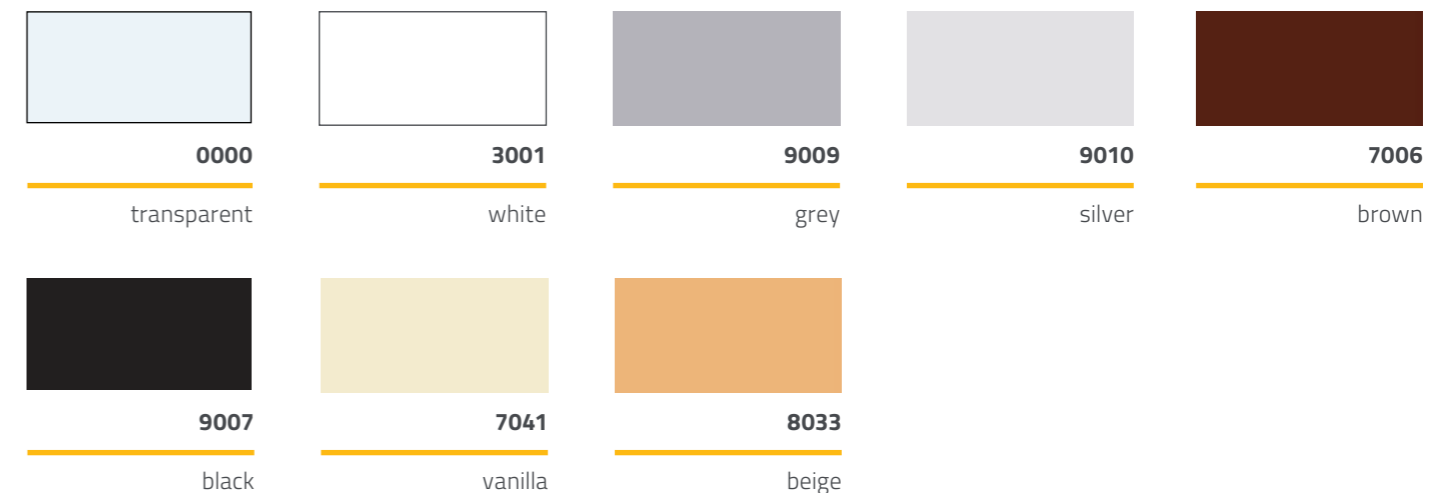

COUNTERTOP AND PLINTH SEALINGS



Sealings designed for countertops and under plinths effectively protect them against penetration of dirt and moisture. They are a discreet finish of gaps between top and wall, or plinth and floor. Functionality, simple assembly and exceptional aesthetics are their main advantages.

COUNTERTOP SEALINGS

PROFILE	INDEX	CATALOGUE NAME	TECHNICAL DRAWING [MM]	PACKAGING
AP 268	268G.0000K3000.38.00	countertop sealing strip		20 pcs. x 3 lm
AP 269	269G.0000K3000.28.00	countertop sealing strip		20 pcs. x 3 lm

PLINTH SEALINGS

PROFILE	INDEX	CATALOGUE NAME	TECHNICAL DRAWING [MM]	PACKAGING
AP 659	659G.0000K3000.00.V2	plinth sealing strip 18 mm		50 pcs. x 3 lm
AP 241	241G.0000K3000.16.00	plinth sealing strip 16 mm		40 pcs. x 3 lm

COLOURS

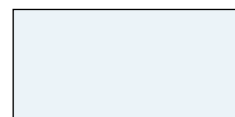

0000

transparent

All sealing strips for furniture tops and plinths are transparent.



WALL SEAL PROFILES

Wall seal profiles are an aesthetic finish of the utility surface in your kitchen between wall and kitchen countertop. Construction of the wall seal profiles guarantees simple assembly and perfect adhesion of the profiles to the wall and countertop. Thermoplast has a wide range of wall seal profiles, together with finishing accessories (internal and external corners, end profiles). Profiles are made of best quality materials and allow customers to enjoy impeccable quality. Modern design and a wide range of colours will satisfy the tastes of the most demanding customers.

AESTHETIC
FINISHING OF
YOUR KITCHEN



MINI WAP CONCAVE **AP 494**

MINI WAP AP 494					
PROFILE	INDEX	CATALOGUE NAME	IMAGE	TECHNICAL DRAWING [MM]	PACKAGING
AP 494	494V.xxxxx3000.00.KL	mini wap			32 pcs. x 3 m

ACCESSORIES AP 494				
PROFILE	INDEX	CATALOGUE NAME	IMAGE	PACKAGING
AK 494	494D.OXXX.AKZ	end profile		100 pcs.
AW 494	494D.OXXX.AWZ	internal corner		50 pcs.
AN 494	494D.OXXX.ANZ	external corner		50 pcs.

RANGE OF COLOURS MINI WAP AP 494 AND ACCESSORIES

accessories 201	accessories 202	accessories 203
201 white	202 black	203 aluminium

MINI WAP CONVEX **AP 495**

MINI WAP AP 495					
PROFILE	INDEX	CATALOGUE NAME	IMAGE	TECHNICAL DRAWING [MM]	PACKAGING
AP 495	495V.xxxxx3000.00.KL	mini wap			20 pcs. x 3 m

AP 495 ACCESSORIES				
PROFILE	INDEX	CATALOGUE NAME	IMAGE	PACKAGING
AK 495	495D.OXXX.AKZ	end profile		100 pcs.
AW 495	495D.OXXX.AWZ	internal corner		50 pcs.
AN 495	495D.OXXX.ANZ	external corner		50 pcs.

RANGE OF COLOURS MINI WAP AP 495 AND ACCESSORIES

accessories 201	accessories 203	accessories 202
201 white	203 aluminium	202 black



MINI WAP CONCAVE DECOR **AP 636**

AP 636

PROFILE	INDEX	CATALOGUE NAME	IMAGE	TECHNICAL DRAWING [MM]	PACKAGING
AP 636	636V.xxxxx3000.00.KL	mini wap			10 pcs. x 3 m

ACCESSORIES DO AP 636

PROFILE	INDEX	CATALOGUE NAME	IMAGE	PACKAGING
AK 636	494D.OXXX.AKZ	end profile		100 pcs.
AW 636	494D.OXXX.AWZ	internal corner		50 pcs.
AN 636	494D.OXXX.ANZ	external corner		50 pcs.

RANGE OF COLOURS MINI WAP AP 636 AND ACCESSORIES

accessories 235	accessories 301	accessories 901	accessories 161
235 beige jute	301 white	901 black	161 silver



WALL SEAL PROFILE **AP 120**

Our wall sea profiles are an indispensable finishing part of every kitchen. Made from the finest materials, they let you enjoy impeccable quality for a long time. RANGE OF COLOURS perfectly matches decors of kitchen countertops of leading manufacturers in Poland.





IDEAL MATCH!



AP 120

PROFILE	IMAGE	INDEX	CATALOGUE NAME	TECHNICAL DRAWING [MM]	PACKAGING
AP 120		120V.xxxxx.3000.00.00	wallseal profile		32 pcs. x 3 lm 10 pcs. x 3 lm*

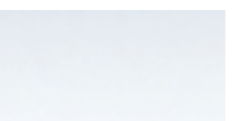

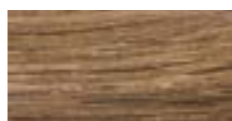

RANGE OF COLOURS WALL SEAL AP 120 AND ACCESSORIES





accessories 116	accessories 1007	accessories 909	accessories 1004	accessories 206
116 beech	141 alder	161 silver	193 light marble	206 wenge



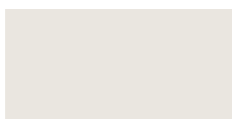

accessories 235  235 juta beige	accessories 284  284 konsuela	accessories 703  285 golden granite	accessories 301  301 white	accessories 706  326 dark walnut
--	---	---	---	--

accessories 1398  1398 oak forever	accessories 1387  1387 dąb wotan
--	--



accessories 816  404 light beech	accessories 708  571 light oak	accessories 841  841 champagne	accessories 901  901 black	accessories 580  1004 sand chip
---	--	--	---	---

accessories 308  1515 bianka	accessories 901  1519 dolores	accessories 909  820 silver matt	accessories 1105  1105 white gloss	accessories 1905  1905 black gloss
---	---	--	---	--

accessories 1514  1249 light travertine	accessories 591  0785 jasmine	accessories 1905  1251 andromeda	accessories 1511  1245 sonoma oak	accessories 500  1253 siena oak
--	---	--	--	---

accessories 901 *  1314 diamond black	accessories 116 *  1356 retro wood	accessories 1105 *  1357 andromeda white II	accessories 1358f *  1358 canyon oak	accessories 284 *  1533 tassili dark
--	--	---	---	--

accessories 903 *  1534 atelier light	accessories 284 *  1536 concrete	accessories 1910  1910 black	accessories 899  899 graphite	accessories 1110  1110 white matt
--	--	--	--	---

AP 120 ACCESSORIES				
PROFILE	INDEX	CATALOGUE NAME	IMAGE	PACKAGING
AW 120	120D.OXXX.AW	internal corner		25 pcs.
AN 120	120D.OXXX.AN	external corner		25 pcs.
AK 120	120D.OXXX.AK	end profile		25 pcs.



ALUMINIUM WALL SEAL PROFILE **AP 121 A**

Wall seal profile has the advantages of a traditional countertop wall seal profile and an aluminum cover. The main advantages of the profile are resistance to deformation under the influence of high temperatures and easy and quick assembly.

AP 121 A					
PROFILE	INDEX	CATALOGUE NAME	IMAGE	TECHNICAL DRAWING [MM]	PACKAGING
AP 121 A	121A.xxxxx.3000.00AL	aluminium wall seal profile			10 pcs. x 3 lm

RANGE OF COLOURS AP 121 A AND ACCESSORIES

accessories 841	accessories 830	accessories 1105	accessories 1905	accessories 901
OC30S	OC000A	9016	9005	C35AN
inox brushed	anoda silver	white gloss	black gloss	anoda black

ACCESSORIES AP 121 A

PROFILE	INDEX	CATALOGUE NAME	IMAGE	PACKAGING
AW 120	120D.OXXX.AW	internal corner		25 pcs.
AN 120	120D.OXXX.AN	external corner		25 pcs.
AK 120	120D.OXXX.AK	end profile		25 pcs.

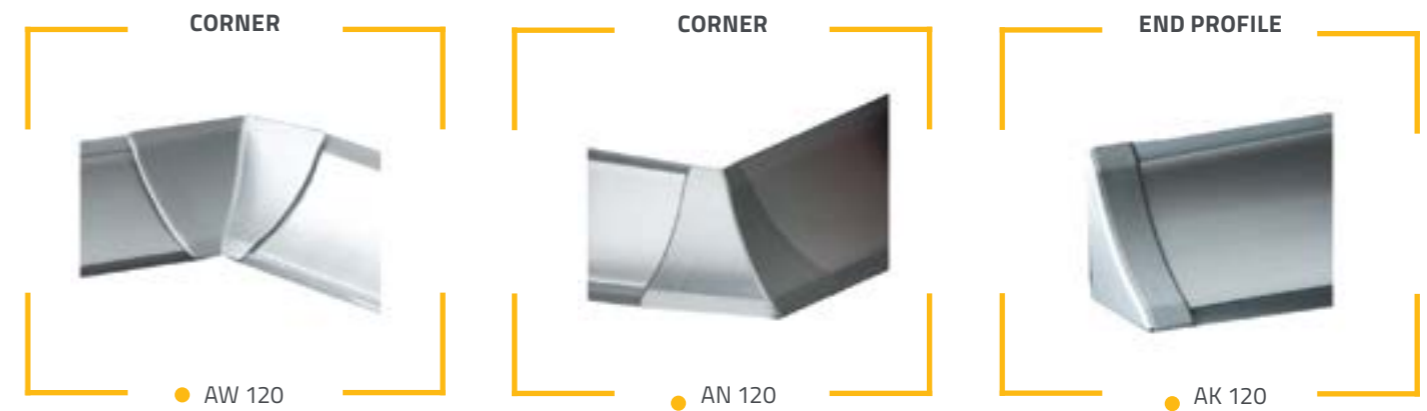



ALUMINIUM COVER FOR WALL SEAL PROFILE **AP 120 A**

AP 120 A					
PROFILE	INDEX	CATALOGUE NAME	IMAGE	TECHNICAL DRAWING [MM]	PACKAGING
AP 120 A	120A.xxxxx0800.00.AL	aluminium cover			1 pcs. x 0,8 lm

RANGE OF COLOURS AP 120 A



Innovative aluminium cover is a reliable protection of the profile. It protects against deformation under the influence of high temperatures. Cover does not require gluing or additional joints.

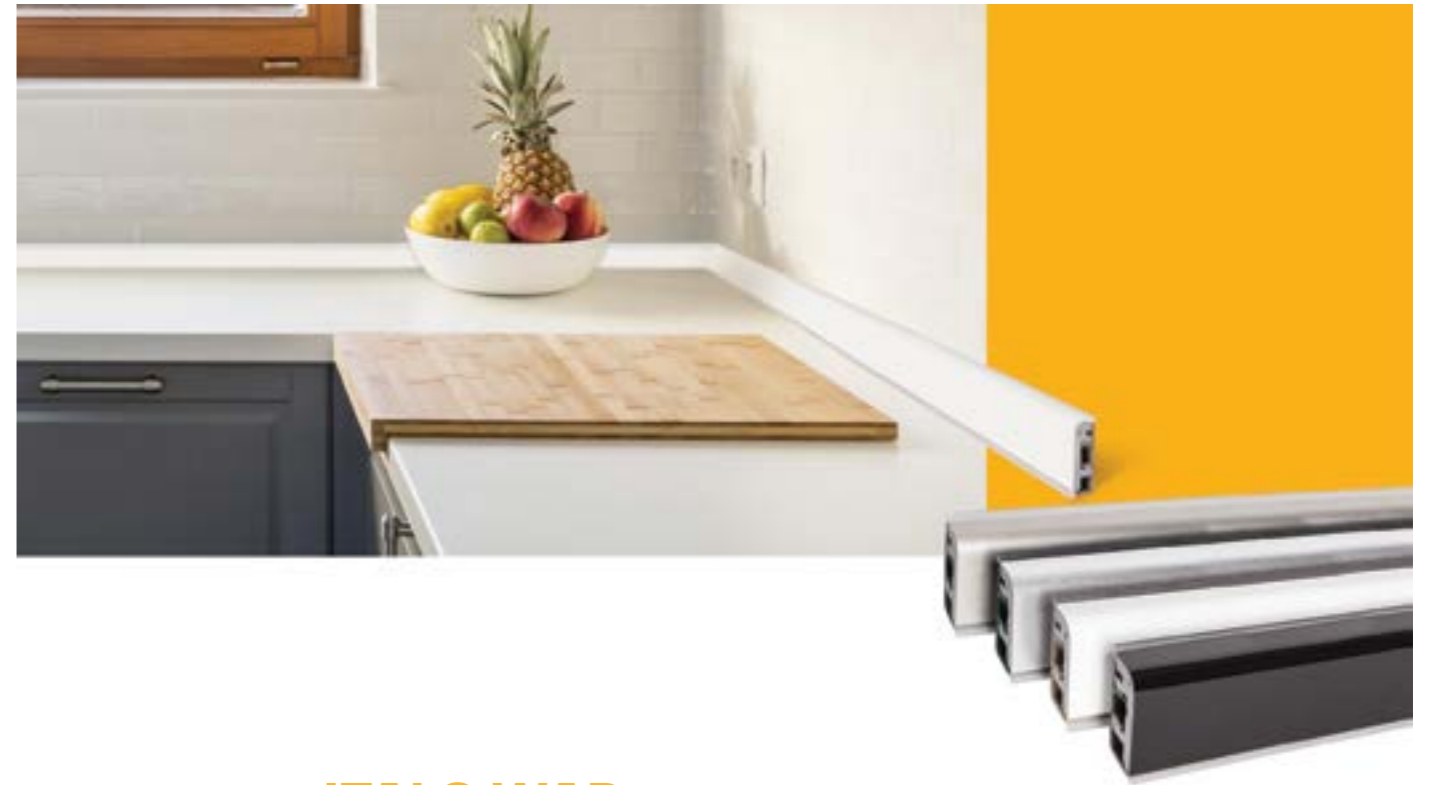

WALL SEAL PROFILE **ITALO WAP**

The ITALO WAP wall seal profile is a harmony of functionality and beauty. It has been made of durable, foamed PVC, and has gaskets to protect against dirt and moisture. Cutting corners is as simple as with wooden slats. Perfect bonding with glue or silicone. Profile can also be finished with dedicated corners and end profiles.

SUBTLE FINISHING

ITALO WAP AP 630					
PROFILE	INDEX	CATALOGUE NAME	IMAGE	TECHNICAL DRAWING [MM]	PACKAGING
AP 630	630B.xxxxx3000.00.KP	italo wap			8 pcs. x 3 lm

RANGE OF COLOURS ITALO WAP AND ACCESSORIES

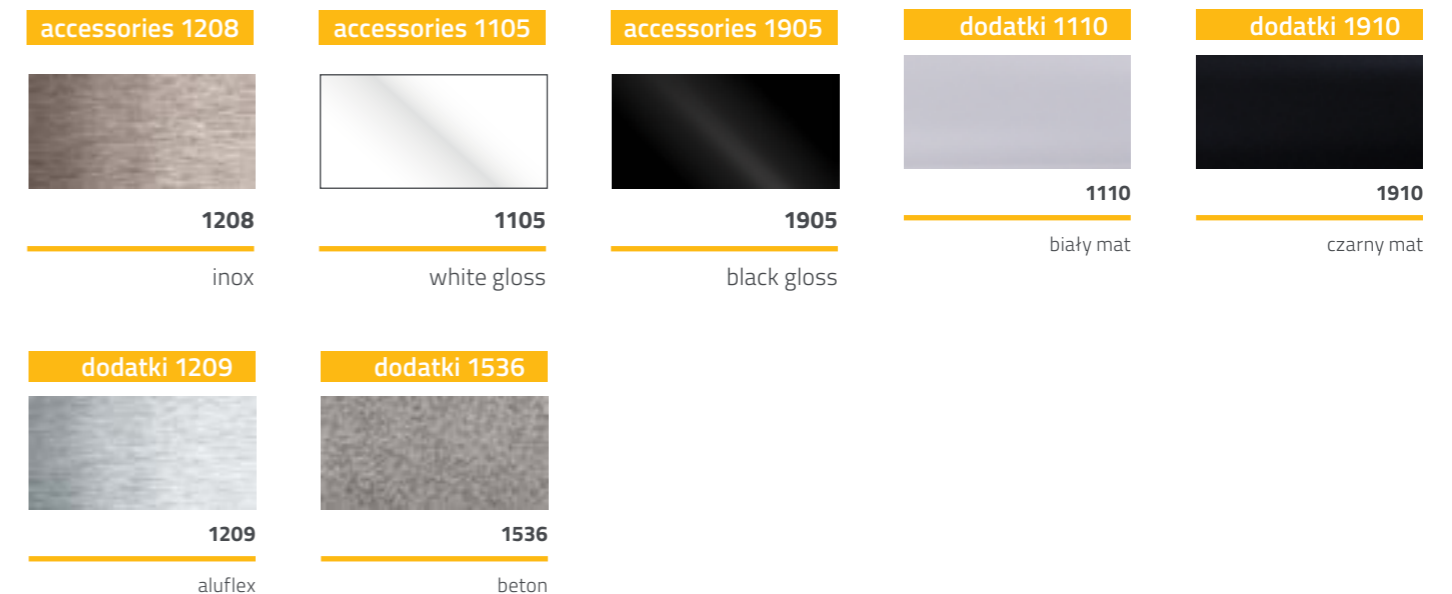



POSSIBILITY OF USING PROFILES IN A VERTICAL AND HORIZONTAL POSITION

ITALO WAP AP 630 ACCESSORIES				
PROFILE	INDEX	CATALOGUE NAME	IMAGE	PACKAGING
AW 630	630D.XXXX.AW	internal corner		5 pcs.
AN 630	630D.XXXX.AN	external corner		5 pcs.
AK 630	630D.XXXX.AK	end profile		5 sets. (5 pcs.left end profiles + 5 pcs.right end profiles)
SET	630D.XXXX.SET	set AW, AN, AK		sets 1 pceach.

EXCLUSIVE COLLECTION OF INOX FINISHING PROFILES



// FURNITURE PLINTHS

MODERN SLIM plinths are intended for elastic finishing of kitchen cabinets. Their presence in your kitchen is a step towards novelty and elegance. Thanks to our plinths, you will easily maintain cleanliness and tidiness beneath your kitchen furniture!

**FUNCTIONALITY
AND ELEGANCE** //

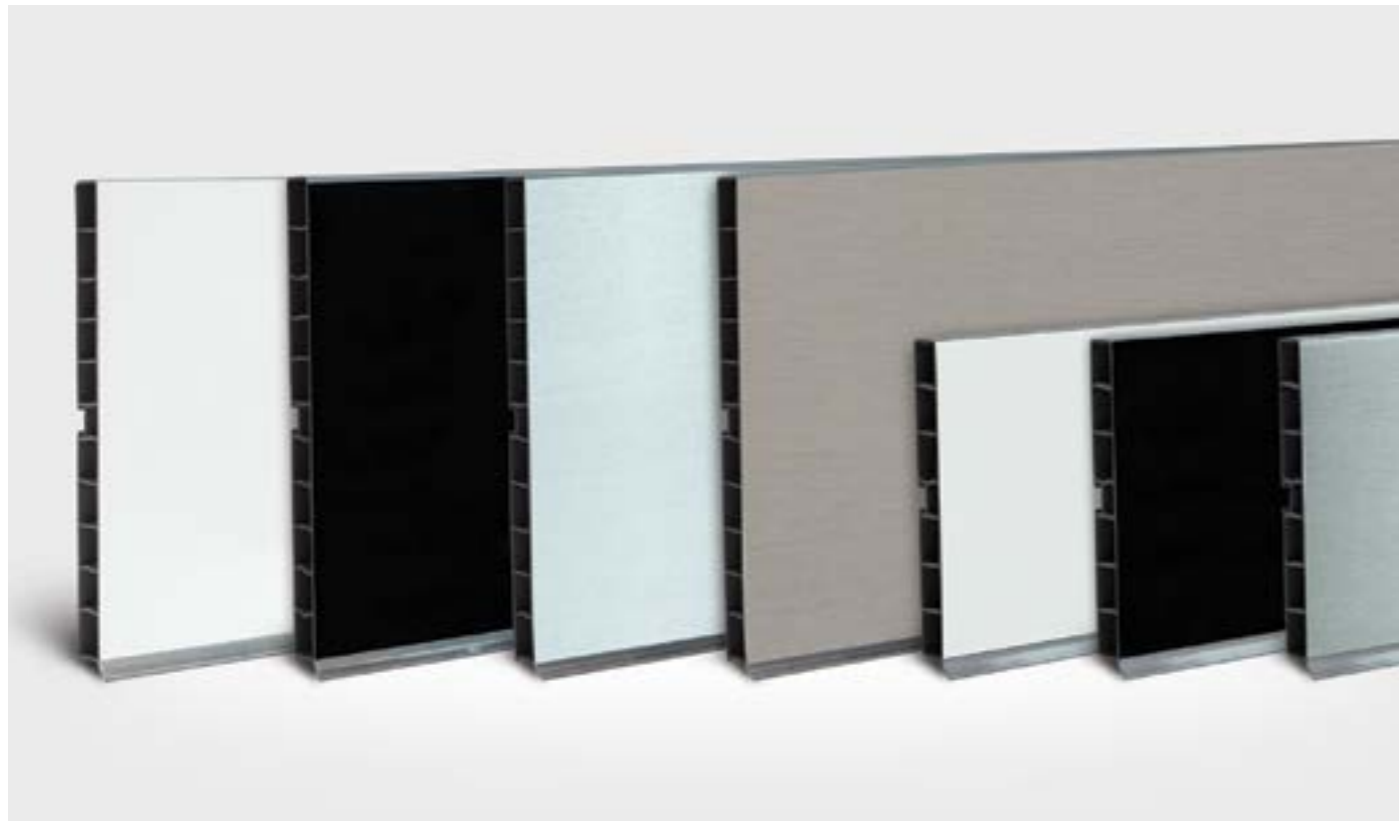

FURNITURE PLINTH CLASSIC

PROVEN AND RELIABLE FINISHING OF KITCHEN FURNITURE

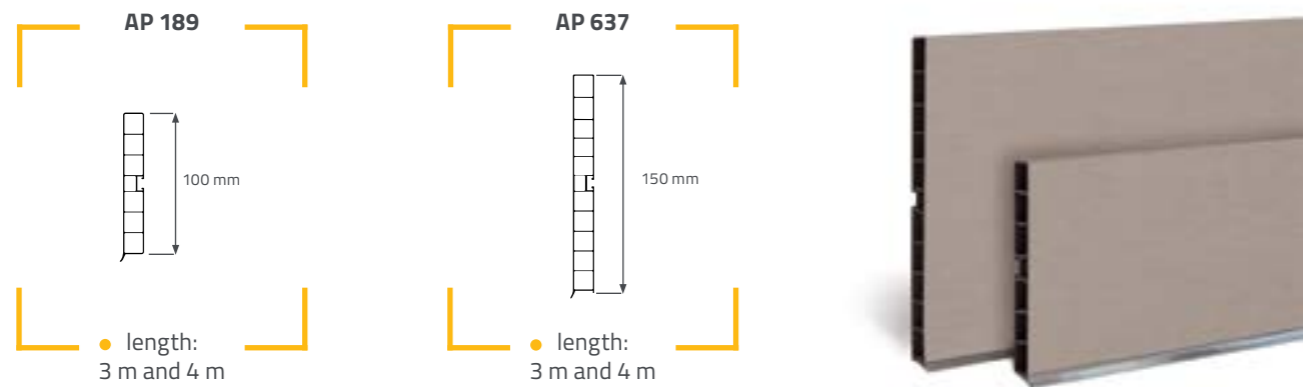

CLASSIC PLINTHS			
PROFILE	INDEX	CATALOGUE NAME	PACKAGING
AP 189	189B.XXXXXA.XXX.XX	plinth 100	10 pcs. x 3 m
AP 637	637B.XXXXXA.XXX.XX	plinth 150	10 pcs. x 3 m

CLASSIC PLINTHS COLOUR RANGE

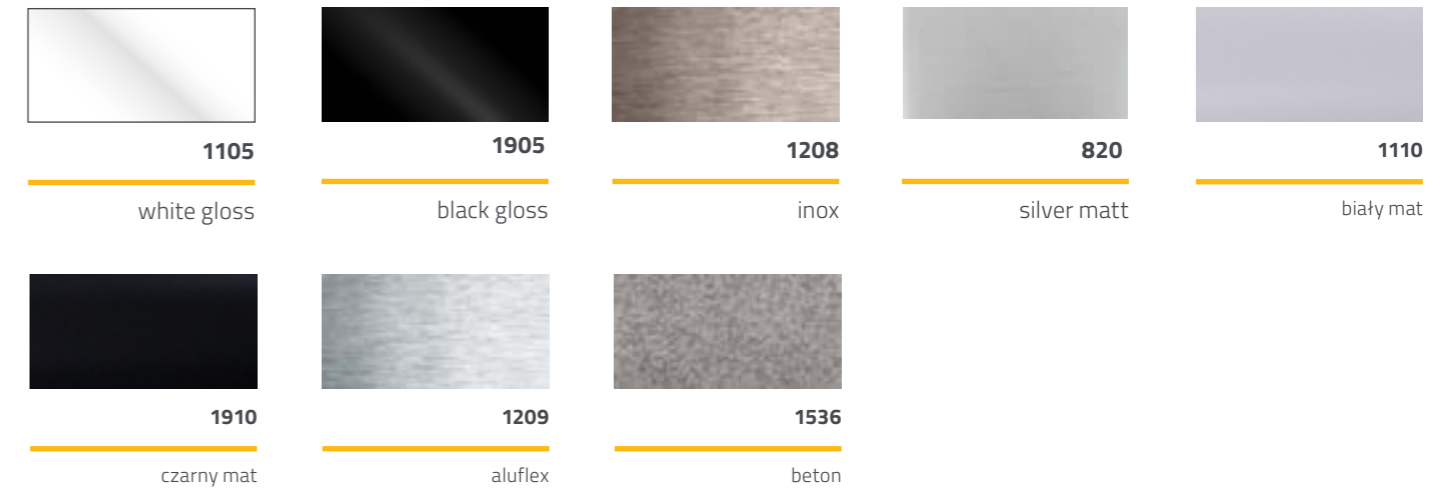

ACCESSORIES IN PLINTH'S COLOUR

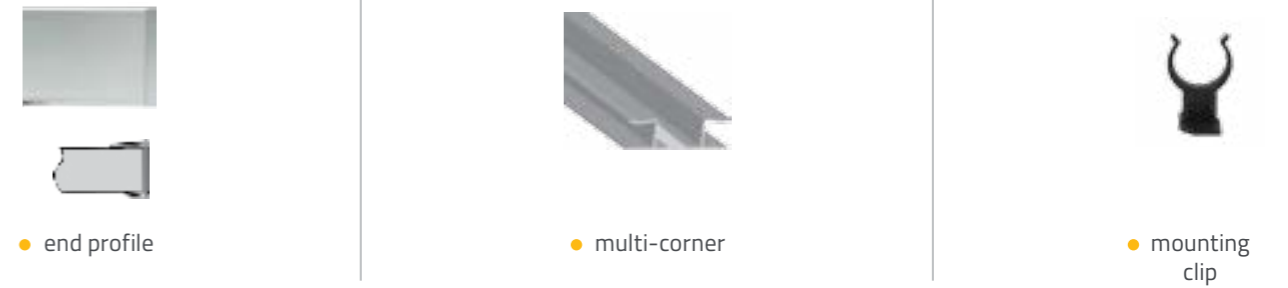

CLASSIC PLINTH ACCESSORIES			
PROFILE	INDEX	CATALOGUE NAME	PACKAGING
APK 189	189D.XXXX.APK	end profile	25 pcs.
APK 637	637D.XXXX.APK	end profile	25 pcs.
AMC 189	189D.XXXX.AMC	multi-corner	10 pcs.
AMC 637	189D.XXXX.AMC	multi-corner	10 pcs.
ADM189/637	189D.0300.K	mounting clip	100 pcs.



// FURNITURE SHUTTERS

They replace traditional furniture fronts not only in kitchen and office cabinets. This solution can also be found in workshops, supermarkets, specialist cars, campers, yachts. Fast and easy assembly and express implementation is the reason for the popularity of this solution in the furniture industry. The shutters made by Thermoplast are made of high quality plastic or aluminium. Available in a wide range of colours, they satisfy the tastes of the most demanding customers.

**OPTIMAL
USE OF SURFACE** //

PVC FURNITURE SHUTTERS



SHUTTER AP 470

TECHNICAL
DRAWING

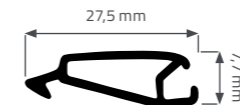

• AP 470



SHUTTER AP 270

TECHNICAL
DRAWING

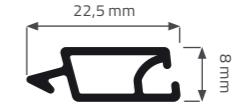

• AP 270

RANGE OF COLOURS AP 470



MT 470 - 161

silver

RANGE OF COLOURS AP 270



MR 270 - 820

silvermatt

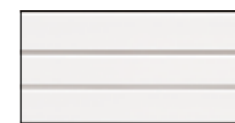

MR 270 - 1105

white



MR 270 - 1905

black

READY MADE SETS – SIZE PER REQUEST

SHUTTERS AVAILABLE IN:

- ready-made sets, which guarantees quick and easy assembly
- profiles, which is a favorable offer for manufacturers expecting the lowest cost calculation and non-standard solutions

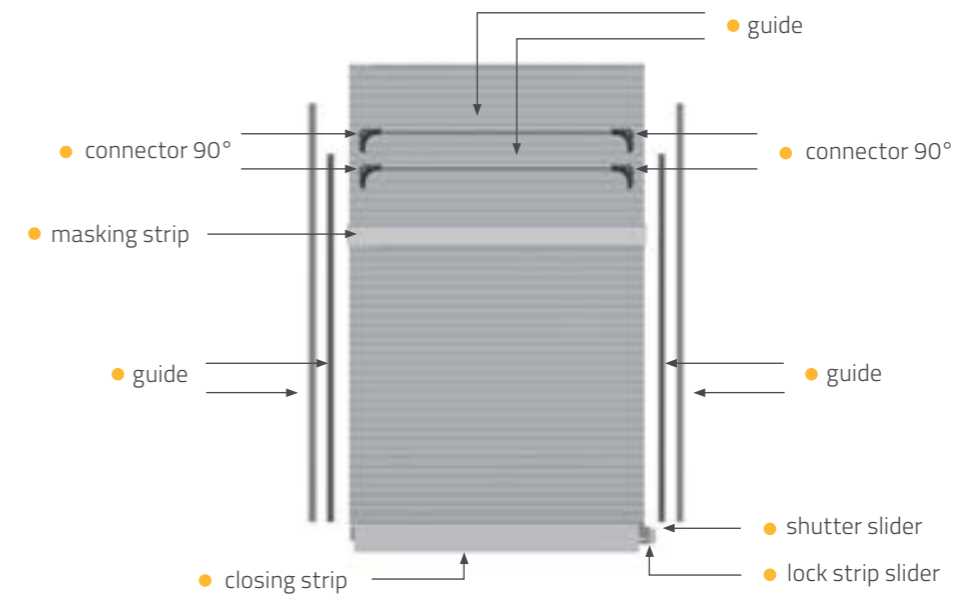

SHUTTER SYSTEM IN FURNITURE FRAME

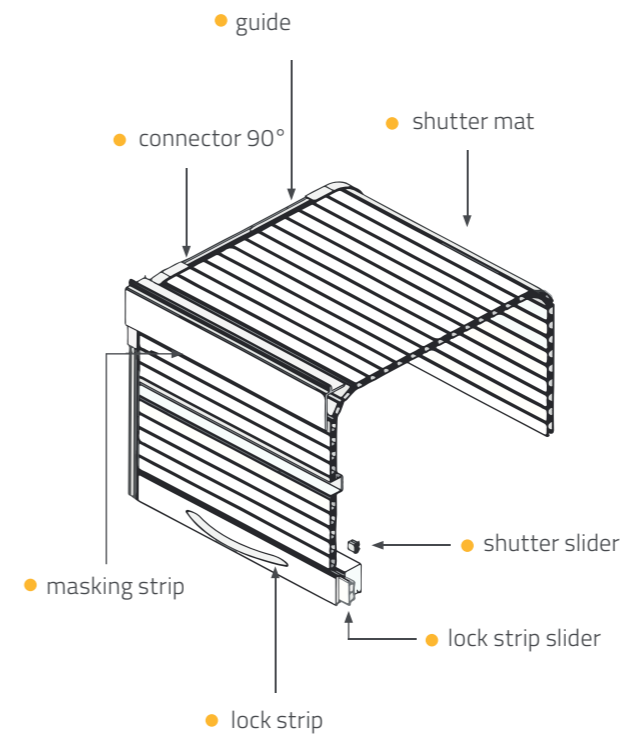

MAX. DIMENSIONS OF THE FRAME

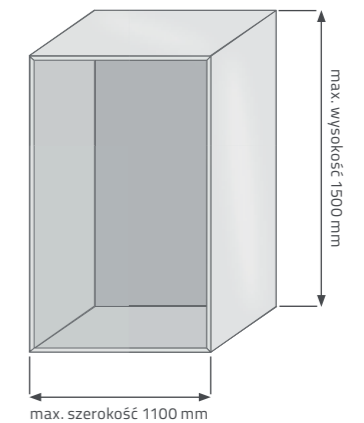

In order to meet the clients' demand for ready-made sets of furniture blinds, our company makes them for any size up to 1500 mm in height and 1100 mm in width.

PVC FURNITURE SHUTTERS



excellent price-quality ratio



innovative technical solutions



fast and easy to assemble



wide range of colours

FURNITURE SHUTTERS IN PROFILES FOR INDIVIDUAL CUT TO SIZE

PROFILE	INDEX	CATALOGUE NAME	IMAGE	PROFILE CROSS SECTION	PACKAGING AND COLOUR
MR 270	270Z.xxxxF2600.00.00	shutter profile			45 pcs. x 2,6 lm colours: 820, 1105, 1905
MT 470	470Z.xxxxT2600.00.00	shutter profile			40 pcs. x 2,6 lm colours: 116, 141, 161, 076, 097
AP 271	271Z.xxxxK2600.00.00	internal guide			14 pcs. x 2,6 lm colours: 301, 901, 909, 832, 816, 740
AP 272	272Z.xxxxK2600.00.00	external guide + base			14 pcs. x 2,6 lm colours: 909, 301, 901, 816, 832, 740, 830, 1208
MR 276 MT 276	276Z.xxxxx2600.00.00	lock strip profile			3 pcs. x 2,6 lm colours: 820, 1105, 1905, 116, 141, 161, 076, 097
MR 277	277Z.xxxxF2600.00.00	lock strip profile			3 pcs. x 2,6 lm colours: 820, 1105, 1905
MR 712	712Z.xxxxx2600.00.00	lock strip profile			3 pcs. x 2,6 lm colours: 830, 1208
MR 713	713Z.xxxxT2600.00.00	masking strip profile			6 pcs. x 2,6 lm colours: 820, 830, 1208, 1105, 1905, 116, 141, 161, 076, 097
AZ 270 AZ 470	270D.0000.AZ 470D.0000.AZ 710D.0000.AZZ	shutter slider profile			100 pcs. colours: transparent
AZ 271	271D.0xxx.AZ	internal arc 90° for a guide AP 271			10 pcs. colours: 301, 901, 909, 832, 816, 740
AZ 273	273D.0xxx.AZ	external arc 90° for a guide AP 272			10 pcs. colours: 301, 901, 909, 832, 816, 740
AZ 277	277D.0xxx.AZ	lock strip slider			10 pcs. colours: 301, 901, 909, 832, 816, 740



EDGE BANDING

Edge bandings are necessary as finishing elements of furniture, which have a decisive impact on their aesthetics, durability and functionality. Their task is to finish the raw edges of furniture boards. Their colours, structure and gloss are selected in terms of a particular furniture board. In our offer, PVC edge bandings come in a wide range of colours and sizes for both the carpentry market and furniture industry.

EXQUISITE FINISHING

2 LOCK TYPES FOR PROFILES MR/MT 276, MR 712

VERTI LOCK

insert
ø 18 mm x 32 mm



HUWIL LOCK

insert
ø 16,5 mm x 22 mm



















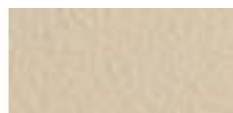

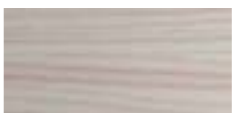

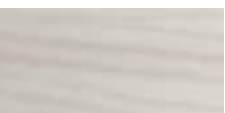









EDGE BANDING			
PROFILE	INDEX	CATALOGUE NAME	PACKAGING
AP 374 22 X 0,6 (MM)	374TXXXXX.250.22.0	PVC edge banding	6 x 250 lm
AP 376 22 X 1 (MM)	376TXXXXX.150.22.0	PVC edge banding	6 x 150 lm
AP 377 22 X 2 (MM)	377TXXXXX.100.22.0	PVC edge banding	6 x 100 lm
AP 377 32 X 2 (MM)	377TXXXXX.100.33.0	PVC edge banding	4 x 100 lm
AP 214 42 X 2 (MM)	214TXXXXX.050.42.0	PVC edge banding	1 x 50 lm

EDGE BANDING SIZES































Width (mm)*	THICKNESS (mm)	0,6	1,0	2,0
	22		●	●
33				●
42				●

* We make edges in non-standard widths, e.g. 16 mm, 19 mm, 25 mm, 28 mm, 66 mm on request.















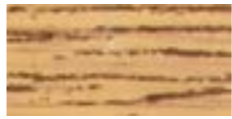



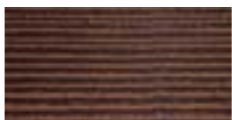

EDGE BANDING RANGE OF COLOURS

 3310 P prega white K110	 3301 smooth white K110	 3322 alaska white U8681SM	 3108 vanilla U108	 3841 vanilla U1313
 3858 sandy U515	 3533 navarra R4524	 3534 werona ash D3158WG	 3219 white maple D2460	 3053 birch H1733
 3535 white rieka oak D3166MX	 3123 milky oak R4120	 3524 honey maple H1521	 3066 vancouver maple D440	 3063 maple D375
 3221 light wenge D2427	 3087 field pear tree D664	 3245 alaska birch R5717	 3361 light palermo oak D2609	 3519 stone pine avola H1476
 3278 sandy zebrano H3006	 3220 seagrass D2298	 3247 light legno R3083	 3188 light swiss pine D2381	 3530 sonora oak D3025
 3083 mangfal beech R5107	 0120 multiplex	 3067 beech D381, R5113	 3104 light locarno apple tree D9475	 3523 natural oak H3389

EDGE BANDING RANGE OF COLOURS

 3526 urbano H3070	 3266 olive D2715	 3112 mountain oak D740, 740KS	 3061 alder	 3191 brown fino F583
 3057 rigoletto D8417	 3536 tabac sonoma oak D5194MX	 3783 cappuccino U3053PE	 3051 grey U2101	 0820 matt silver
 3117 silver D881	 3942 anthracite U1290	 3942 graphite U3114PE	 3068 bavarian beech D1426, D9200	 3193 mountain alder R4634
 3522 cherry H1706	 3069 cherry D D088	 3062 alder D9310	 3294 alder	 3520 merano H3128
 3248 legno tabac R3248	 3517 beige-grey zebrano H3005	 3225 acacia R5717	 3217 african zebrano D2296	 3052 havana nova 8956KS
 3527 merano brown H3129	 3226 toscany nut D2453	 3074 white nut D722, R4842	 3122 calvados D1937	 3165 field peartree D9300, R4964

EDGE BANDING RANGE OF COLOURS

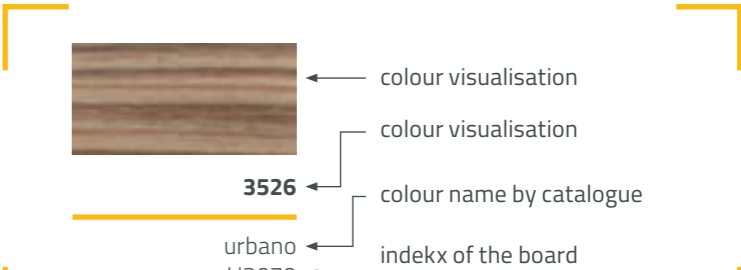
 3072 locarno apple tree D1972	 3075 bologna nut D9451	 3056 plum D2608	 3167 wild pear tree R4967	 3078 red mahogany D775SE
 3114 rustic oak D708	 3222 dark zebrano D2297	 3058 ecco nut D9459	 3186 corsico chestnut R4118	 3059 nut 1925KS
 3218 macassar D2446	 3054 wenge D2227	 3079 togo mahogany D466	 3298 tirol beech H1599	 3055 dark parelmo oak D2610
 3189 chocolate swiss pine D2380	 3076 dark nut D9450	 3050 zebrano D9775	 3187 wenge chestnut	 3160 magic wenge
 3288 ferrara oak H1137	 3901 black U2200	 <p>Diagram illustrating the color visualization and indexing for board 3526 urbano H3070. It shows a color swatch with arrows pointing to 'colour visualisation', 'colour name by catalogue', and 'index of the board manufacturer and board colour'.</p>		

It is possible to individually choose the colour and size of edges to the latest trends in the design of boards and countertops.





// PROFILES C AND T

C and T profiles have long been one of the best methods of finishing furniture. Thanks to the use of high quality materials, our C and T profiles are extremely resistant to abrasion and impact, which protects the furniture panels against damage during operation. It is a simple and aesthetic finish of furniture, tables or countertops.

TIMELESS SOLUTION //

PROFILE C



PROFILE C - AP 088

PROFILE	DESCRIPTION	TECHNICAL DRAWING [MM]	PACKAGING
AP 088	soft PVC profile		2 pcs. x 35 lm

RANGE OF COLOURS AP 088

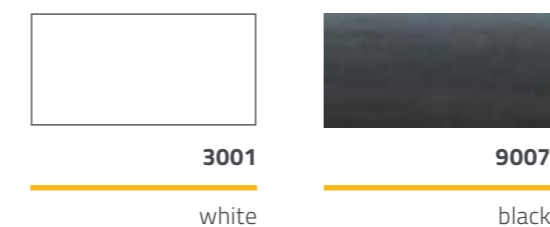

On customer's request, there is a possibility of individual colour selection.

PROFILE C - AP 167*

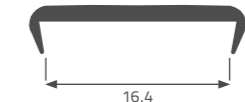
PROFILE	DESCRIPTION	TECHNICAL DRAWING [MM]	PACKAGING
AP 167	softPVC profile		2 pcs. x 35 lm

* This profile is manufactured to customer's order. There is a possibility of individual colour selection.

PROFILE C - AP 353*

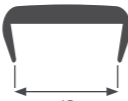
PROFILE	DESCRIPTION	TECHNICAL DRAWING [MM]	PACKAGING
AP 353	soft PVC profile		2 pcs. x 35 lm

* This profile is manufactured to customer's order. There is a possibility of individual colour selection.

PROFILE C - AP 384

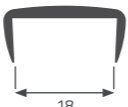
PROFILE	DESCRIPTION	TECHNICAL DRAWING [MM]	PACKAGING
AP 384	hard PVC profile		20 pcs. x 2,6 lm

RANGE OF COLOURS AP 384

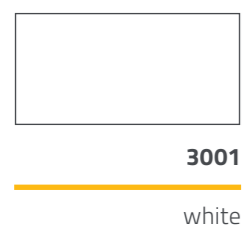

On customer's request, there is a possibility of individual colour selection.

Functionality and ease of installation of our profiles, without the use of expensive, specialized machinery, makes that both furniture-makers, as well as private users, often reach for them to raise the aesthetics of furniture.

PROFILE T



PROFILE T - AP 155

PROFILE	DESCRIPTION	TECHNICAL DRAWING [MM]	PACKAGING
AP 155	hard PVC profile		1 pcs. x 35 lm

RANGE OF COLOURS AP 155

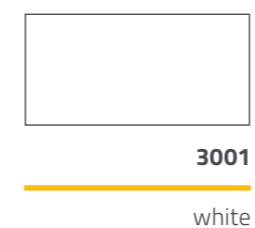

PROFILE T - AP 153*

PROFILE	DESCRIPTION	TECHNICAL DRAWING [MM]	PACKAGING
AP 153	soft PVC profile		1 pcs. x 35 lm

* This profile is manufactured to the customer's order.

PROFILE T - AP 156*

PROFILE	DESCRIPTION	TECHNICAL DRAWING [MM]	PACKAGING
AP 156	soft PVC profile		1 pcs. x 35 lm

* This profile is manufactured to the customer's order.

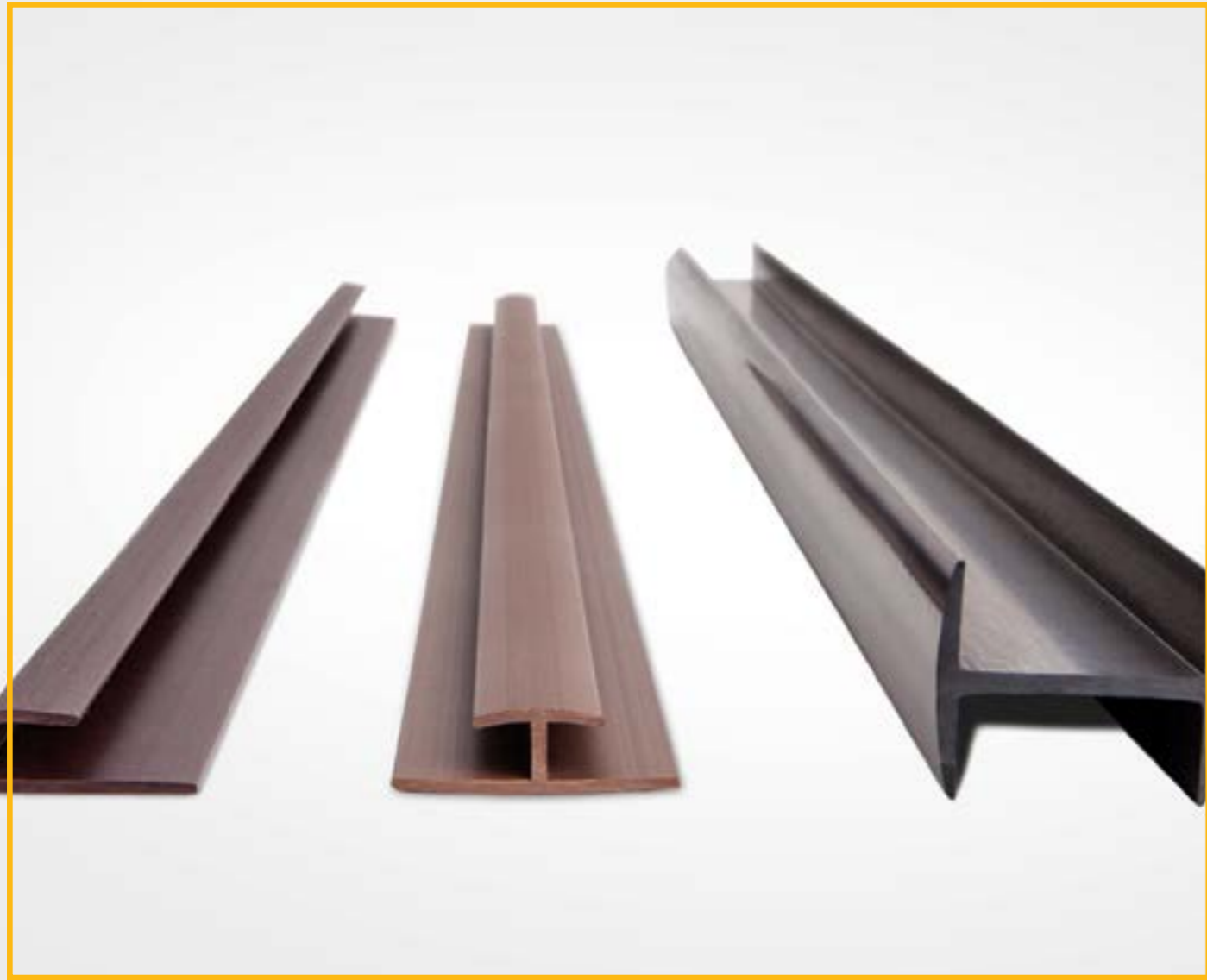

// PROFILES H, J

This group of profiles includes structural profiles for joining and securing furniture boards, H and J. Profiles of this type allow for aesthetic connection of two boards in one plane with a very gentle transition from one to the other. With these profiles, simple assembly eliminates the imperfections of traditional panel joining.

**AESTHETIC
AND EASY
ASSEMBLY** //

PROFILE H - AP 087

PROFILE	INDEX	DESCRIPTION	IMAGE	TECHNICAL DRAWING [MM]	PACKAGING
AP 087	087I.0000K2600.18.20	used for joining two boards (18 mm) in one plate			20 pcs. x 2,6 lm

RANGE OF COLOURS AP 087

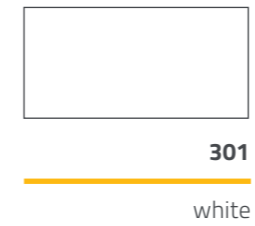

On customer's request, there is a possibility of individual colour selection.

PROFILE H - AP 178

PROFILE	INDEX	DESCRIPTION	IMAGE	TECHNICAL DRAWING [MM]	PACKAGING
AP 178	178L.0000K2600.00.20	used for joining two boards (4 mm) in one plate			20 pcs. x 2,6 lm

RANGE OF COLOURS AP 178

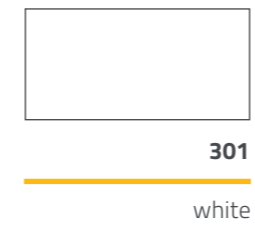

On customer's request, there is a possibility of individual colour selection.

PROFILE J - AP 177

PROFILE	INDEX	DESCRIPTION	IMAGE	TECHNICAL DRAWING [MM]	PACKAGING
AP 177	177I.0000K2600.00.20	used for finishing 4 mm boards			20 pcs. x 2,6 lm
AP 177	177I.0301K2600.00.00	used for finishing 4 mm boards			100 pcs. x 2,6 lm

RANGE OF COLOURS AP 177

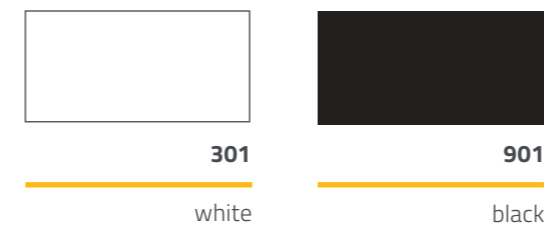

On customer's request, there is a possibility of individual colour selection.



// ALUMINIUM PROFILES

Aluminium profiles in our offer are used as handles mounted to furniture fronts. Their durability, universal application, modern design and availability meet the high requirements of customers. Our handle profiles have gained recognition for quality and have been recognized for their colouristic repeatability. The current collection is systematically extended with the most popular solutions on the market.

**MODERN
DESIGN** //

ALUMINIUM HANDLE PROFILES

PROFILE	INDEX	IMAGE	TECHNICAL DRAWING [MM]	COLOUR	PACKAGING
AL 105	AL105KW.OC30S3000.PK			inox (OC30S)	10 pcs. x 3 lm
AL 105	AL105KW.OC00A3000.PK			anoda silver (OC00A)	10 pcs. x 3 lm
AL 107	AL107KW.OC30S3000.PK			inox (OC30S)	10 pcs. x 3 lm
AL 107	AL107KW.OC00A3000.PK			anoda silver (OC00A)	10 pcs. x 3 lm
AL 109	AL109KW.OC30S3000.PK			inox (OC30S)	10 pcs. x 3 lm
AL 109	AL109KW.OC00A3000.PK			anoda silver (OC00A)	10 pcs. x 3 lm

ALUMINIUM PROFILES RANGE OF COLOURS



OC00A

anodasilver



OC30S

inox

* Range of colours in the catalogue may slightly differ from actual colours.

// MARKETING MATERIALS

In order to meet the expectations of our contractors, and to facilitate display and sale of Thermoplast products, we give full marketing support in the form of various advertising materials, templates, displays, stands, discount actions, bonus schedules, promotions in media and trade fairs.

Thanks to this, all information about our products is easily available, which makes easier to make a decision about purchasing our profiles

STANDS, TEMPLETS



BANNERS



LEAFLEATS, POSTERS, FOLDERS, MAILINGS



SAMPLE CHARTS, ROLL-UPS



MARKETING GADGETS



PROMOTIONS, BONUS SCHEDULES



PROFFESIONAL PRODUCT-SALE TRAININGS

*We want to support you
- Thermoplast employees.*



GUARANTEED COVER AND PRIVACY FOR PROPERTIES, TERRACES AND BALCONIES

// FENCE STRIPS

Fence strips are an innovative solution that allows you to create modern, aesthetic and functional fencing systems for people, who want to keep their privacy on their property, in the garden or at the balcony.

PATTERNS



IDEAL FOR:



SIZES

190 mm		95 mm		47,5 mm	
1 box	26 lm	1 box	52 lm	1 box	50 lm
1 m ²	5 lm	1 m ²	10 lm	1 m ²	20 lm
1 box	5 m ²	1 box	5 m ²	1 box	2,5 m ²

END CLIPS



Esthetic clip for fixing strips to a panel.

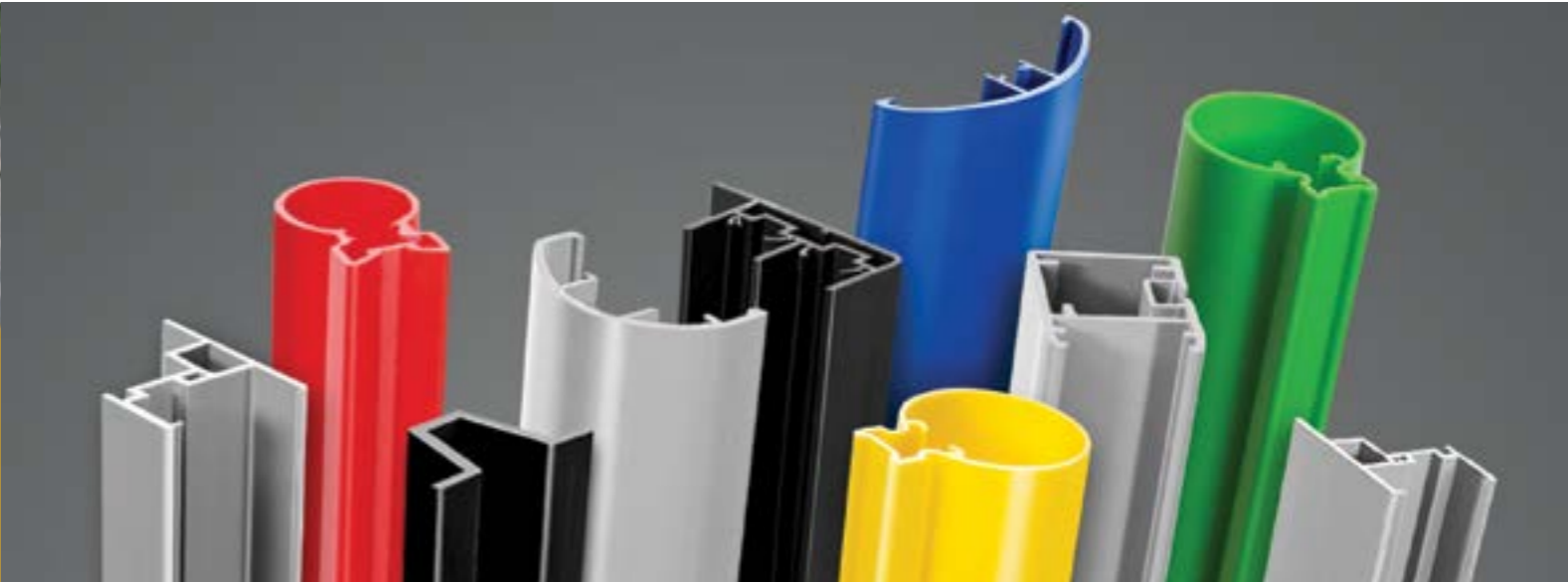

// TECHNICAL PROFILES

We specialize in designing and building tools for extrusion, and in extrusion technology of profiles, which meet the expectations of individual investors from various industries.

IMPLEMENTATION OF INDIVIDUAL PROJECTS

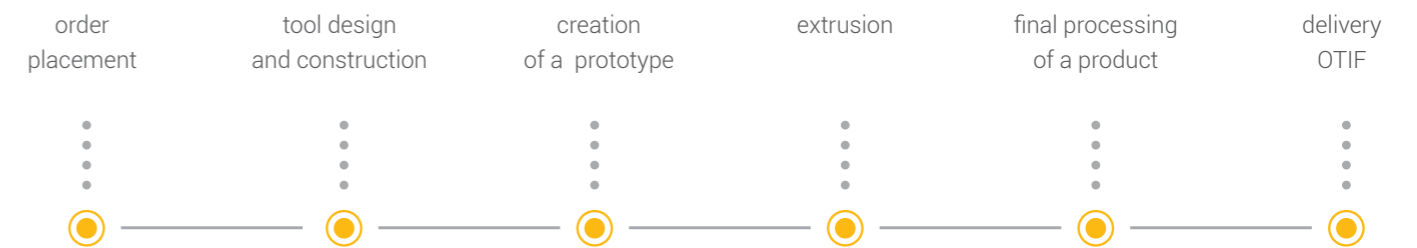

WIDE APPLICATION OF PROFILES IN INDUSTRIES

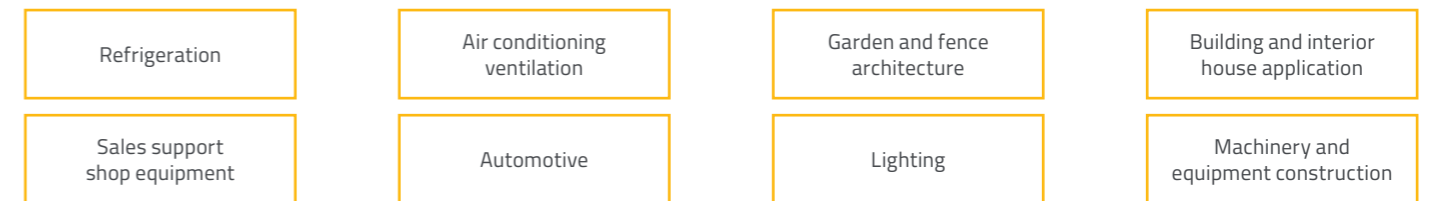

TECHNICAL PROFILES CATALOGUES





// CONTACT

Thermoplast Technology P.S.A.
ul. Wilcza 3
32-590 Libiąż
www.thermoplast.eu

SALES DEPARTMENT:
Tel: +48 32 625 86 36
Mobile: +48 669 121 610
E-mail: export@thermoplast.eu

OFFICE:
Tel: +48 32 627 19 82
Fax: +48 32 623 13 64
Fax: +48 32 623 06 78
E-mail: biuro@thermoplast.eu

**FEEL FREE TO CONTACT US!
WE SPEAK YOUR LANGUAGE!**



WWW.THERMOPLAST.EU