

# FENCE STRIPS

cover and privacy

## CATALOGUE



 **Thermoplast**<sup>®</sup>



## WE SPECIALIZE IN EXTRUSION OF PLASTIC PROFILES

- ThermoPlast has over 30 years of experience in designing and building tools for extrusion, co-extrusion and post-extrusion of custom technical profiles for clients from various industries.
- We offer a wide range of standard profiles for various industries, including: furniture, refrigeration, ventilation, air-conditioning, fencing and agricultural, garden architecture, construction, sales support. We also implement individual projects, even most complex technical profiles in terms of shape, material and conditions of use.
- ThermoPlast® is a leader among manufacturers and suppliers of original fence tapes systems on the Polish market, including fencing strips made of the highest quality polypropylene.
- We offer the widest range of original fencing strips and covers for standard 2D and 3D panels as well as fencing meshes and balcony railings on the Polish market. The offer varies both in terms of the method of mounting, structure of the strips, their width and color, which makes it possible to create functional, aesthetic, individually designed fences.

### THERMOPLAST® KEY PRODUCT GROUPS



#### TECHNICAL PROFILES

INNOVATIVE, UNIQUE PROFILES WITH A WIDE APPLICATION FOR VARIOUS INDUSTRIES



#### FENCE STRIPS

GUARANTEED PRIVACY ON THE PROPERTY, TERRACE AND BALCONY



#### FURNITURE PROFILES

MODERN SOLUTIONS FOR FURNITURE INDUSTRY

# THERMOPLAST® ORIGINAL FENCE STRIPS

## EXCELLENT COVER FOR YEARS

### // CONTENTS

<b>ADVANTAGES OF USING STRIPS</b> .....	<b>04</b>
<b>HORIZONTAL MOUNTING SYSTEM</b> .....	<b>05</b>
APPLICATION AND BENEFITS .....	06
FENCE STRIPS - CLASSIC LINE .....	08
FENCE STRIPS - SMART MATT .....	09
FENCE STRIPS - ORANGE SKIN .....	10
FENCE STRIPS - BASIC .....	11
FENCE STRIPS - LITE TAPE .....	12
FENCE STRIPS - LARGE TECHNORATTAN .....	13
<b>VERTICAL MOUNTING SYSTEM</b> .....	<b>14</b>
FENCE STRIPS - SIMPLE LINE .....	14
FENCE COVERS - THE GUARD .....	16
<b>CUSTOM MADE COLORS</b> .....	<b>19</b>



# THERMOPLAST® ORIGINAL FENCE STRIPS

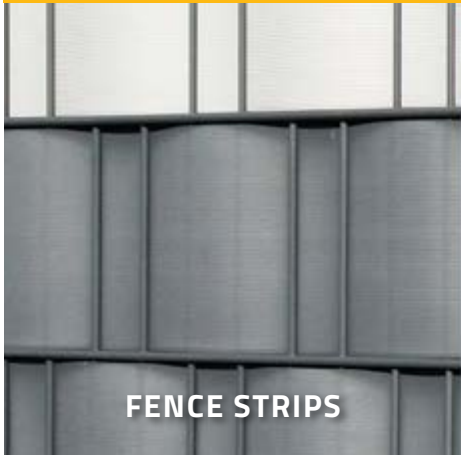

## FENCE STRIPS THERMOPLAST®

### ORIGINAL FENCE COVERS

MADE IN **UE**

protection and privacy on properties,  
terraces and balconies

Thermoplast® fencing covers are an innovative solution that allows to create modern, aesthetic and functional fencing fillings for people who want to maintain privacy on the property, in the garden

or on the balcony. They are perfect for fencing panels, mesh fencing and balustrades of balconies.

### ADVANTAGES OF USING THERMOPLAST® COVERS

- ✓ UV resistant, do not discolour in the sun
- ✓ remain soft and flexible when bent
- ✓ frost-resistant, unbreakable in low temperatures
- ✓ do not deform in high temperatures
- ✓ provide an aesthetic appearance on both sides of a fence panel
- ✓ do not require maintenance and impregnants
- ✓ easy and quick assembly without the use of specialized tools
- ✓ variety of applications (panels, balcony railings, mesh panels)
- ✓ protection against wind and adverse weather conditions.
- ✓ modern design and various widths

# THERMOPLAST® ORIGINAL FENCE STRIPS

## HORIZONTAL MOUNTING

### Thermoplast® fence strips

perfect for filling panels, mesh fences and balcony railings, providing an aesthetic and durable cover. We offer them in a wide range of colors and patterns and in various widths.



## VERTICAL MOUNTING

### Simple Line System

a functional and aesthetic polypropylene cover for 2D and 3D fencing panels. A set consists of 60 meters of fencing tape and 100 assembly clips. We offer Simply Line in several widths, patterns and colors.

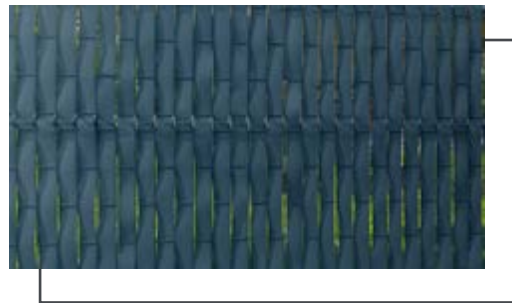

### The Guard System

a set of plastic slats that is matched to 3D fence panels. The Guard is available in several sizes, so it can be used in the most popular heights of 3D panels.



## THERMOPLAST® ORIGINAL FENCE COVERS ARE A GUARANTEE OF THE HIGHEST QUALITY PRODUCTS

All production processes in Thermoplast® are certified in accordance with ISO 9001, and the quality is controlled by specialists throughout production process.



IDEAL SOLUTION FOR:



PRIVATE PROPERTIES



ESTATES



WAREHOUSES



# THERMOPLAST® ORIGINAL FENCE STRIPS

## TECHNICAL DATA

Material	Polypropylene (PP)
Darkening	≈100%
Application	fencing panels, mesh fences, balcony railings
Weight	~552 gramm/m <sup>2</sup> , ~630 gramm/m <sup>2</sup> , 789 gramm/m <sup>2</sup>
Assembly	assembly without the use of specialized tools
Assembly	horizontal mounting



## MODERN DESIGN



CLASSIC LINE



SMART MAT



ORANGE SKIN



LITE TAPE



BASIC



TECHNORATTAN LARGE

## AVAILABLE WIDTHS



190 mm

1 box	26 m
1 m <sup>2</sup>	5 lm
1 box	5 m <sup>2</sup>



190 mm

1 box	35 m
1 m <sup>2</sup>	5 lm
1 box	7 m <sup>2</sup>



95 mm

1 box	52 m
1 m <sup>2</sup>	10 lm
1 box	5 m <sup>2</sup>



47,5 mm

1 box	50 m
1 m <sup>2</sup>	20 lm
1 box	2,5 m <sup>2</sup>

## MOUNTING CLIPS FOR FENCE STRIPS



UNIVERSAL CLIP AP 828

End profile with strong handle suitable for each wire thickness in a panel.

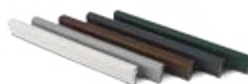

STANDARD CLIP AP 785

End profile for panels with wires with a cross-section 4 - 6 mm.



OMEGA CLI AP 888

End profile for panels with wires with a cross-section 3,5 - 5,5mm.

# THERMOPLAST® ORIGINAL FENCE STRIPS

The use of best quality plastic - **Polypropylene**, guarantees the highest UV resistance, durability and flexibility of fencing strips.



MADE IN  
EU



INNOVATIVE  
SOLUTION



HIGHEST  
QUALITY



FAST AND EASY  
ASSEMBLY

## HORIZONTAL MOUNTING

How in a quick and easy way  
turn a garden, terrace or balcony into a private space?



Waive the fence tape  
onto the panel.

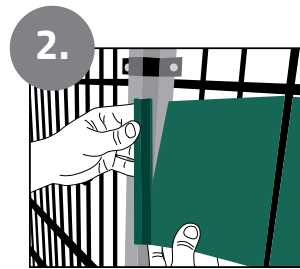

Fasten the tape  
in the end clip.

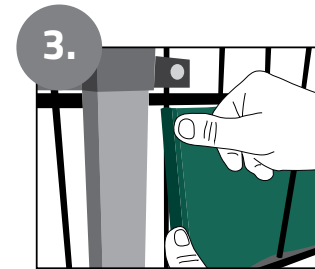

Attach the end clip with  
the fence strip to the panel.

## CALCULATION

NUMBER OF PALLETS	PANEL SIZE [M X M]				
	2,5 X 1,2	2,5 X 1,4	2,5 X 1,6	2,5 X 1,8	2,5 X 2,0
1	1	1	1	1	1
2	2	2	2	2	2
3	2	3	3	3	3
4	3	3	4	4	4
5	3	4	4	5	5
6	4	5	5	6	6
7	5	5	6	7	7
8	5	6	7	8	8
9	6	7	8	9	9
10	6	7	8	9	10
15	9	11	12	14	15
20	12	14	16	18	20
30	18	21	24	27	30
40	24	28	32	36	40
50	30	35	40	45	50

box 190 mm x 26 lm - [5 m<sup>2</sup>]

NUMBER OF PALLETS	PANEL SIZE [M X M]				
	2,5 X 1,2	2,5 X 1,4	2,5 X 1,6	2,5 X 1,8	2,5 X 2,0
1	1	1	1	1	1
2	2	2	2	2	2
3	2	3	3	3	3
4	3	3	4	4	4
5	3	4	4	5	5
6	4	5	5	6	6
7	5	5	6	7	7
8	5	6	7	8	8
9	6	7	8	9	9
10	6	7	8	9	10
15	9	11	12	14	15
20	12	14	16	18	20
30	18	21	24	27	30
40	24	28	32	36	40
50	30	35	40	45	50

box 95 mm x 52 lm - [5 m<sup>2</sup>]

NUMBER OF PALLETS	PANEL SIZE [M X M]				
	2,5 X 1,2	2,5 X 1,4	2,5 X 1,6	2,5 X 1,8	2,5 X 2,0
1	2	2	2	2	2
2	3	3	4	4	4
3	4	5	5	6	6
4	5	6	7	8	8
5	6	7	8	9	10
6	8	9	10	11	12
7	9	10	12	13	14
8	10	12	13	15	16
9	11	13	15	17	18
10	12	14	16	18	20
15	18	21	24	27	30
20	24	28	32	36	40
30	36	42	48	54	60
40	48	56	64	72	80
50	60	70	80	90	100

box 47,5 mm x 50 lm - [2,5m<sup>2</sup>]

# THERMOPLAST® ORIGINAL FENCE STRIPS

## CLASSIC LINE



MADE IN  
POLAND



PREMIUM  
PRODUCT



MADE OF  
BEST QUALITY  
POLYPROPYLENE



RESISTANT  
TO WEATHER  
CONDITIONS



RESISTANT TO  
RADIATION,  
COLOR DURABILITY



10 YEAR  
WARRANTY

### MOUNTING CLIPS



AP 785

### AVAILABLE WIDTHS:



190 mm



95 mm



47,5 mm

## CLASSIC LINE FENCE STRIP

PROFILE NAME	WIDTH	THICKNESS	WEIGHT	PACKAGE		INDEX
				ROLL	STRIPS	
701	190 mm	1,65 mm	750-770 gramm/m <sup>2</sup>	ROLL	26 lm	701P.XXXXXK0026.190.P
				STRIPS	10 x 2,55 m	701P.XXXXXK2550.190.P
					10 x 2,53 m	701P.XXXXXK2530.190.P
					10 x 2,52 m	701P.XXXXXK2520.190.P
706	95 mm	1,65 mm	750-770 gramm/m <sup>2</sup>	ROLL	2 x 26 lm	706P.XXXXXK0026.95.X2
685	47,5 mm	1,3 mm	750-770 gramm/m <sup>2</sup>	ROLL	50 lm	685P.XXXX.K0050.47.X2

### CLASSIC LINE - AVAILABLE RANGE OF COLORS



TH 329 (RAL 9003)



TH 520 (RAL 6005)



TH 770 (RAL 8011)



TH 909 (RAL 7040)



TH 947 (RAL 7030)



TH 945 (RAL 7016)



TH 900 (RAL 900)



Other colors of the tapes are made to order.  
Colors presented in the catalog may slightly differ from the actual colors.



# THERMOPLAST® ORIGINAL FENCE STRIPS

## SMART MATT

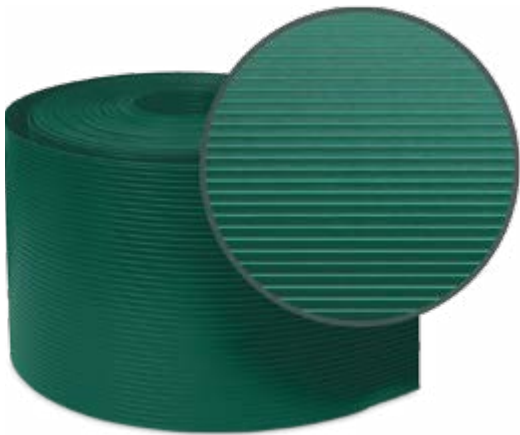

MADE IN  
POLAND



AFFORDABLE  
FOR EVERYONE



MADE OF  
BEST QUALITY  
POLYPROPYLENE



RESISTANT  
TO WEATHER  
CONDITIONS



RESISTANT TO  
RADIATION,  
COLOR DURABILITY



10 YEAR  
WARRANTY

### MOUNTING CLIPS



AP 785

### AVAILABLE WIDTHS:



190 mm

## SMART MATT FENCE STRIP

PROFILE NAME	WIDTH	THICKNESS	WEIGHT	PACKAGE		INDEX
K11	190 mm	1,1 mm	770-790 gramm/m <sup>2</sup>	ROLL	26 lm	K11.XXXXXK0026.190.BL

### SMART MATT - AVAILABLE RANGE OF COLORS



TH 520 (RAL 6005)



TH 909 (RAL 7040)



TH 945 (RAL 7016)



TH 900 (RAL 900)



Other colors of the tapes are made to order.

Colors presented in the catalog may slightly differ from the actual colors.

# THERMOPLAST® ORIGINAL FENCE STRIPS

## ORANGE SKIN



MADE IN  
POLAND



PREMIUM  
PRODUCT



MADE OF  
BEST QUALITY  
POLYPROPYLENE



RESISTANT  
TO WEATHER  
CONDITIONS



RESISTANT TO  
RADIATION,  
COLOR DURABILITY



10 YEAR  
WARRANTY

### MOUNTING CLIPS



AP 888

Dedicated to K08



AP 785

Dedicated to K12

### AVAILABLE WIDTHS:



190 mm

## ORANGE SKIN FENCE STRIP

PROFILE NAME	WIDTH	THICKNESS	WEIGHT	PACKAGE		INDEX
K08	190 mm	0,85 mm	580-600 gramm/m <sup>2</sup>	ROLL	26 lm	K08.XXXXXK0026.190.05
K12	190 mm	1,20 mm	580-600 gramm/m <sup>2</sup>	ROLL	26 lm	K12.XXXXXK0026.190.05
				STRIPS	10 x 2,55 m	K12.XXXXXK2550.190.05

## ORANGE SKIN - AVAILABLE RANGE OF COLORS



TH 520 (RAL 6005)



TH 909 (RAL 7040)



TH 945 (RAL 7016)



TH 900 (RAL 900)



Other colors of the tapes are made to order.  
Colors presented in the catalog may slightly differ from the actual colors.

# THERMOPLAST® ORIGINAL FENCE STRIPS

## BASIC

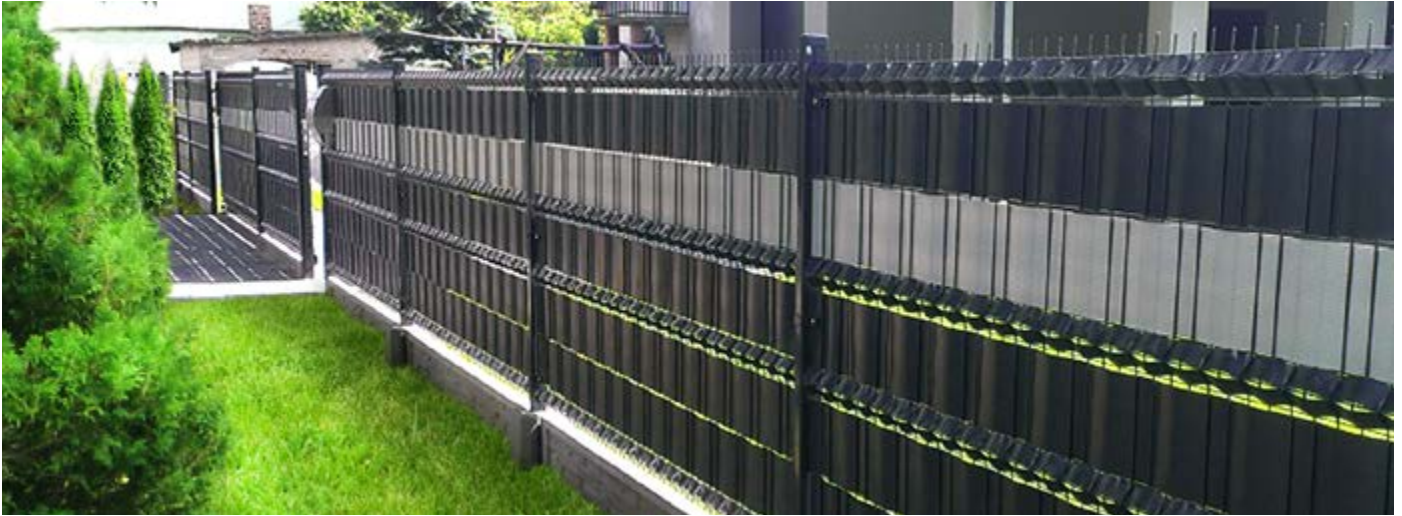

MADE IN  
POLAND



AFFORDABLE  
FOR EVERYONE



MADE OF  
BEST QUALITY  
POLYPROPYLENE



RESISTANT  
TO WEATHER  
CONDITIONS



RESISTANT TO  
RADIATION,  
COLOR DURABILITY



10 YEAR  
WARRANTY

### MOUNTING CLIPS



AP 888

### AVAILABLE WIDTHS:



190 mm

## BASIC FENCE STRIP

PROFILE NAME	WIDTH	THICKNESS	WEIGHT	PACKAGE		INDEX
K06	190 mm	0,65 mm	550-570 gramm/m <sup>2</sup>	ROLL	26 lm	K06.XXXXk0026.190.ST
				PE SLEEVE	50 lm	K06.XXXXK0050.190.BS
					35 lm	K06.XXXXK0035.190.BS
					SET	50 lm

## BASIC - AVAILABLE RANGE OF COLORS



TH 329 (RAL 9003)



TH 520 (RAL 6005)



TH 770 (RAL 8011)



TH 909 (RAL 7040)



TH 945 (RAL 7016)



TH 900 (RAL 900)



Other colors of the tapes are made to order.  
Colors presented in the catalog may slightly differ from the actual colors.

# THERMOPLAST® ORIGINAL FENCE STRIPS

## LITE TAPE

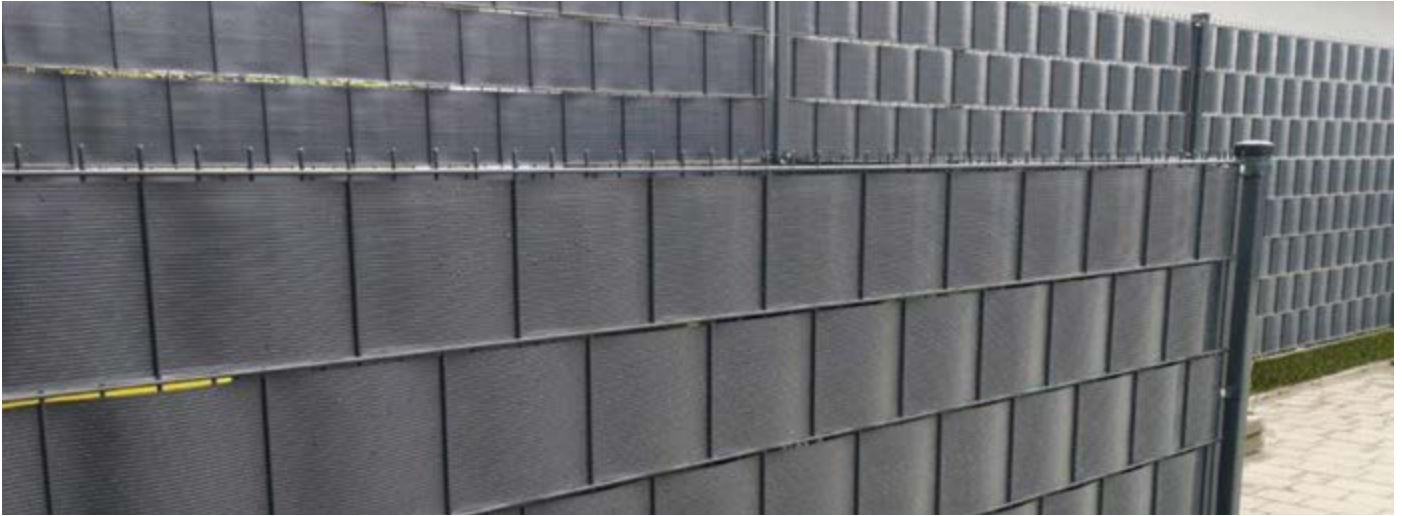

BEST PRICE



RESISTANT TO WEATHER CONDITIONS



RESISTANT TO RADIATION, COLOR DURABILITY



1 YEAR WARRANTY

### PACKAGE

35 m of fence tape  
+20 end clips

### LITE TAPE FENCE STRIP

PROFILE NAME	WIDTH	THICKNESS	WEIGHT	OPAKOWANIE		INDEX
				ROLL	35 lm	
TCH	190 mm	0,65 mm	450 gramm/m <sup>2</sup>	ROLL	35 lm	TCH.XXXXXK0035.190.KL

### LITE TAPE - AVAILABLE RANGE OF COLORS



TH 520 (RAL 6005)

TH 909 (RAL 7040)

TH 945 (RAL 7016)



Other colors of the tapes are made to order.  
Colors presented in the catalog may slightly differ from the actual colors.

# THERMOPLAST® ORIGINAL FENCE STRIPS

## TECHNORATTAN LARGE



MADE IN  
POLAND



PREMIUM  
PRODUCT



MADE OF  
BEST QUALITY  
POLYPROPYLENE



RESISTANT  
TO WEATHER  
CONDITIONS



UV PROTECTION  
RESISTANT TO  
RADIATION,  
COLOR DURABILITY



10 YEAR  
WARRANTY

### MOUNTING CLIPS



AP 785

### AVAILABLE WIDTHS:



190 mm

## TECHNORATTAN LARGE FENCE STRIP

PROFILE NAME	WIDTH	THICKNESS	WEIGHT	PACKAGE		INDEX
K20	190 mm	2,0 mm	1210-1250 gramm/m <sup>2</sup>	ROLL	26 lm	K20.XXXXXK0026.190.RW
				ROLL	5,1 lm	K20.XXXXXK5100.190.RW
				STRIPS	10 x 2, 55 m	K17.XXXXXK2550.190.RW

### TECHNORATTAN LARGE - AVAILABLE RANGE OF COLORS

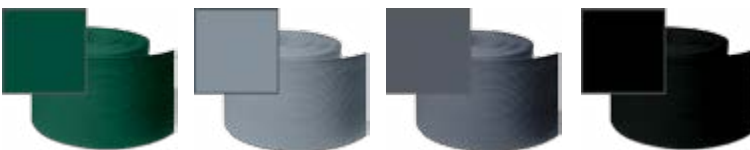

TH 520 (RAL 6005)

TH 909 (RAL 7040)

TH 945 (RAL 7016)

TH 900 (RAL 900)



Other colors of the tapes are made to order.  
Colors presented in the catalog may slightly differ from the actual colors.

# THERMOPLAST® ORIGINAL FENCE STRIPS

## SIMPLE LINE SYSTEM



MADE IN  
POLAND



AFFORDABLE  
FOR EVERYONE



MADE OF  
BEST QUALITY  
POLYPROPYLENE



RESISTANT  
TO WEATHER  
CONDITIONS



RESISTANT TO  
RADIATION,  
COLOR DURABILITY



10 YEAR  
WARRANTY

## TECHNICAL DATA

Material	Polypropylene (PP)
Darkening	≈100%
Application	2D and 3D panels
Weight	550-570 gramm/m <sup>2</sup> , 580-600 gramm/m <sup>2</sup>
Assembly	assembly without the use of specialized tools
Assembly	vertical assembly

## PACKAGE

60 m of fence tape  
+100 end clips

## SIMPLE LINE - BASIC SYSTEM

PROFILE NAME	WIDTH	THICKNESS	WEIGHT	PACKAGE	INDEX
SP.K06	44 mm	0,65 mm	550-570 gramm/m <sup>2</sup>	ROLL 60 lm	SP.K06.XXXXK060.44.B5
	48 mm			ROLL 60 lm	SP.K06.XXXXK060.48.B5
	50 mm			ROLL 60 lm	SP.K06.XXXXK060.50.B5
	55 mm			ROLL 60 lm	SP.K06.XXXXK060.55.B5

## SIMPLE LINE - ORANGE SKIN SYSTEM

PROFILE NAME	WIDTH	THICKNESS	WEIGHT	PACKAGE	INDEX
SP.K08	44 mm	0,85 mm	580-600 gramm/m <sup>2</sup>	ROLL 60 lm	SP.K08.XXXXK060.44.O5
	48 mm			ROLL 60 lm	SP.K08.XXXXK060.48.O5
	50 mm			ROLL 60 lm	SP.K08.XXXXK060.50.O5
	55 mm			ROLL 60 lm	SP.K08.XXXXK060.55.O5

# THERMOPLAST® ORIGINAL FENCE STRIPS

## MODERN DESIGN

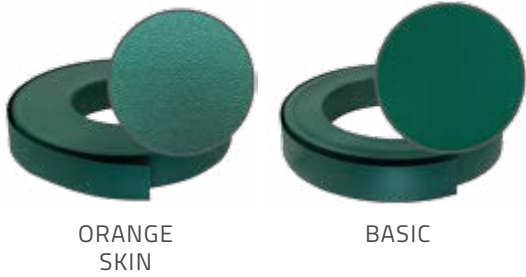

## COLORS



## MOUNTING CLIPS



## AVAILABLE WIDTHS

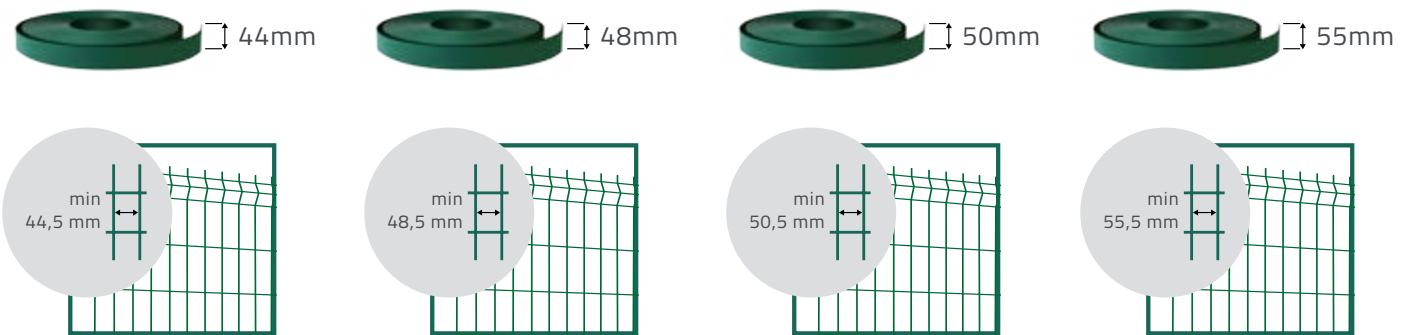

## FAST AND EASY ASSEMBLY

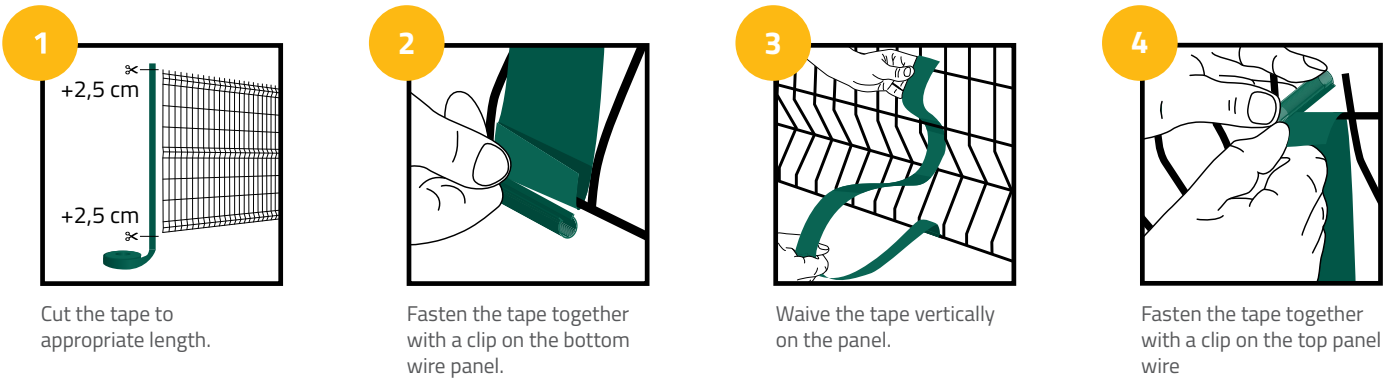

## QUICK CALCULATION

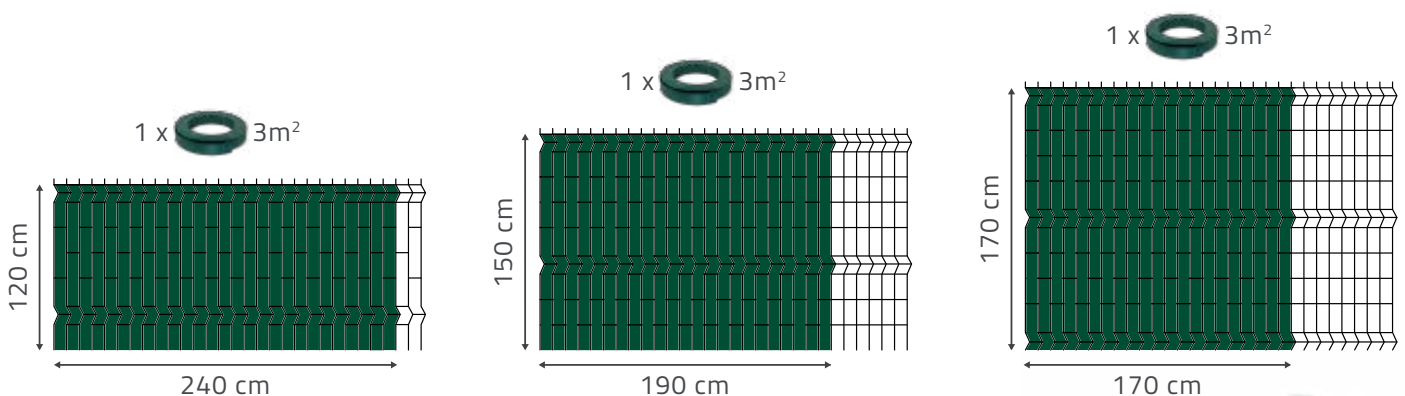

# THERMOPLAST® ORIGINAL FENCE COVERS

## THE GUARD SYSTEM



MADE IN  
POLAND



AFFORDABLE  
FOR EVERYONE



MADE OF  
BEST QUALITY  
POLYVINYL CHLORIDE



RESISTANT  
TO WEATHER  
CONDITIONS



RESISTANT TO  
RADIATION,  
COLOR DURABILITY



10 YEAR  
WARRANTY

## TECHNICAL DATA

Material	Polyvinyl chloride (PVC)
Darkening	≈100%
Application	2D and 3D fence panels
THICKNESS (main profile wall)	0,70 mm
Assembly	assembly without the use of specialized tools
Assembly	vertical assembly



It is not recommended to install  
**TheGuard** in very windy areas  
(*safety considerations*).

## THE GUARD SYSTEM

PROFILE NAME	SLAT WIDTH	SPACING BETWEEN PANEL WIRES	MAIN PROFILE WALL THICKNESS	PACKAGE	PANEL
THE GUARD	44 mm	50 mm	0,70 mm	SET	2,5 M X 1,03 M
				SET	2,5 M X 1,23 M
				SET	2,5 M X 1,53 M
				SET	2,5 M X 1,73 M
				SET	2,5 M X 1,93 M
				SET	2,5 M X 2,03 M
THE GUARD	48mm	55 mm	0,70 mm	SET	2,5 M X 1,03 M
				SET	2,5 M X 1,23 M
				SET	2,5 M X 1,53 M
				SET	2,5 M X 1,73 M
				SET	2,5 M X 1,93 M
				SET	2,5 M X 2,03 M



# THERMOPLAST® ORIGINAL FENCE COVERS

## COLORS

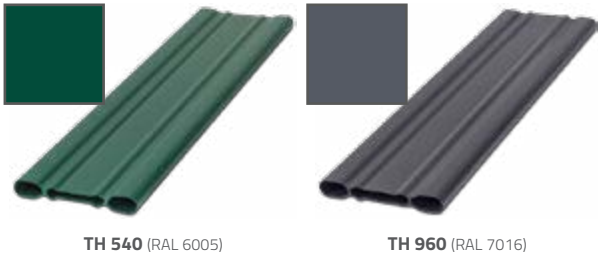

TH 540 (RAL 6005)

TH 960 (RAL 7016)

## COMPATIBILITY

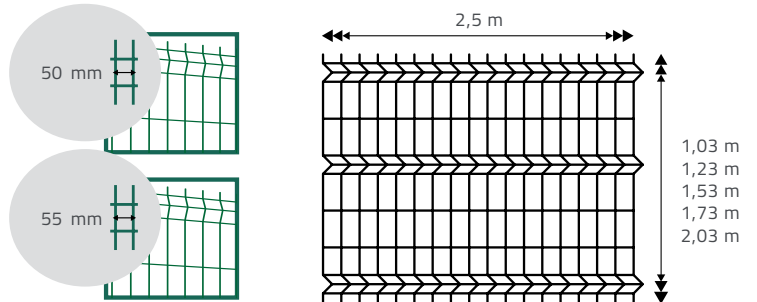

## THE SET CONSISTS OF

Each **TheGuard** set contains all necessary elements to cover 1 panel.

### THE GUARD SYSTEM

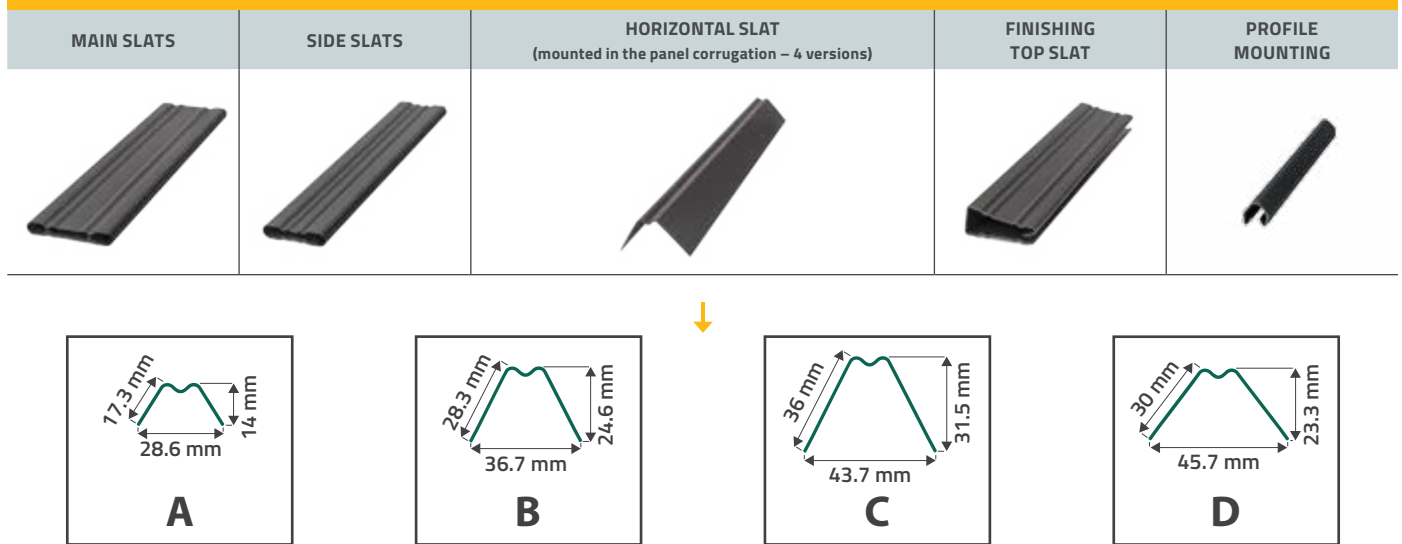

The set consists of:

- main slats for vertical mounting
- 2 side slats for vertical mounting  
(2 narrower slats to be mounted at both ends of the panel)
- horizontal slat mounted in the panel corrugation
- finishing top slat
- mounting profile mounted on the lower horizontal wire

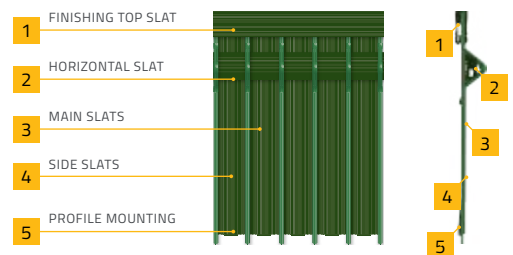

## FAST AND EASY ASSEMBLY

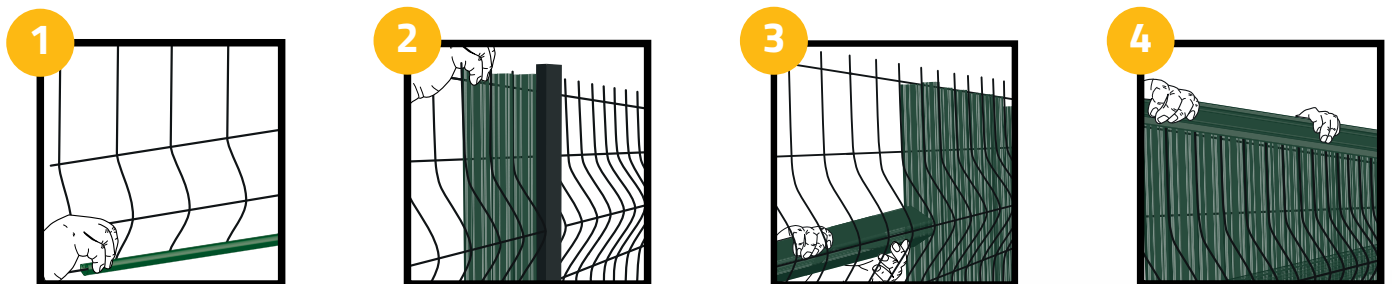

Install mounting profiles vertically on the lower horizontal wire.

Slide the side and main slats vertically and place them inside the mounting profile.

Slide the trapezoidal strip horizontally in the panel corrugation.

Mount the finishing top slat horizontally

# THERMOPLAST® ORIGINAL FENCE STRIPS

## WARNING!

Check with the drawing, if **The Guard** system fits your fence.  
How to do it? It's easy!

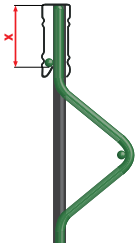

**x** – maximum vertical wire height from the highest horizontal wire on the fence.

**$x < 33\text{mm}$**

If dimension **x** is less than 33 mm, select the appropriate type of horizontal "M" slat.

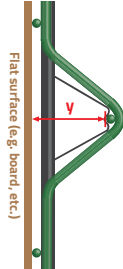

Put a flat, stable surface against the horizontal bars on the back part of the fence and measure the distance „**y**“, then compare it with the data in the table.

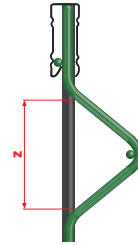

Measure the distance „**z**“ and compare with notes in the table in „**B**“ and „**D**“ fields.

Fence measurements (distance „y“)	Suggested horizontal "M" slat type	Comments
20 - 24 mm	A	
30 - 35 mm	B	For 36.7 mm width V-shape hole
36 - 41 mm	C	
30 - 35 mm	D	For 45.7 mm width V-shape hole



# THERMOPLAST® ORIGINAL FENCE STRIPS

## IDEAL FOR



FENCING PANELS



BALUSTRADES



MESH FENCING

## OTHER COLORS OF THE TAPES ARE MADE TO ORDER



TH 329 (RAL 9003)



TH 346 (RAL 9010)



TH 878 (RAL 1023)



TH 629 (RAL 3003)



TH 634 (RAL 3011)



TH 425 (RAL 5010)



TH 770 (RAL 8011)



TH 789 (RAL 8019)



TH 947 (RAL 7030)



TH 909 (RAL 7040)



TH 900 (RAL 900)

- Presented here range of colors is available upon individual order, while each tape design is shown with a generally available standard color scheme.
- Colors presented in the catalog may slightly differ from the actual colors.



# WE INVITE YOU TO COOPERATION!

## ADDRESS:

**Thermoplast Technology P.S.A.**  
ul. Wilcza 3  
32-590 Libiąż, Poland

## SALES DEPARTMENT:

**Phone:** +48 32 625 86 36  
**Phone:** +48 660764922  
**E-mail:** sprzedaz@thermoplast.eu

## OFFICE:

**Phone:** +48 32 627 19 82  
**Fax:** +48 32 623 13 64  
**E-mail:** biuro@thermoplast.eu

**MADE IN**

**POLAND**



[www.thermoplast.eu](http://www.thermoplast.eu)